



LV SERIES

FOR MARINE APPLICATION

FM-200® FIRE SUPPRESSION SYSTEM



The Janus Fire Systems® Lv Series Clean Agent Fire Suppression System for Marine Application utilizes FM-200® as the extinguishing medium. FM-200® is a colorless, non-toxic gas perfectly suited to protect high value assets in areas that may be normally occupied, in locations where clean-up of other agents is problematic, when storage space for a fire suppression agent is restricted, or when an electrically non-conductive agent is required. Each system consists of the following components and their associated accessories:

1. **Agent Storage Components** - These components consist of the cylinder assembly(s), which contains the FM-200® agent, and the agent cylinder bracket(s), which holds the cylinder assembly securely in place. These components are utilized in both arrangements.
2. **Nitrogen Driver Components** - These components consist of the large nitrogen driver cylinder assembly and the nitrogen cylinder bracket(s), which holds the cylinder assembly securely in place. These components are utilized in both arrangements.
3. **Agent Distribution Components** - These components consist of the discharge nozzles used to atomize the liquid FM-200® and introduce it into a protected hazard along with the associated piping system used to connect the nozzles to the cylinder assembly. These components are utilized in both arrangements.
4. **Trim Components** - These components complete the installation of the agent cylinder and nitrogen driver cylinder and consist of connection fittings, pressure gauge, and optional supervisory low-pressure switch. These components are utilized in both arrangements, but the specific components used will vary slightly according to the series valve installed.
5. **Multi-Cylinder Arrangement Components** - These components consist of the pneumatic valve actuator(s), pilot actuation check valve, vent check, actuation hoses, and fittings required for a multiple cylinder (secondary) arrangement. These components are utilized in both arrangements where multiple cylinders are installed on a single discharge manifold.
6. **Supplemental Components** - These components include the discharge pressure switch and may be utilized in a variety of locations within an arrangement or for multiple purposes. These components are utilized in both arrangements as necessary.
7. **Cable Pull Equipment** - Cable-pull equipment is installed to allow the remote manual actuation of the system cylinders. The equipment includes the remote pull station, cable, pulley elbows, and cable-actuated stop valve. These components are utilized in the Cable Pull arrangements.
8. **Remote Nitrogen Actuation Equipment** - Nitrogen actuation equipment is installed to allow the remote pneumatic actuation of the system cylinders. The equipment includes the remote actuation cylinder and pneumatic stop valve. These components are utilized in the Pneumatic Actuation arrangements.
9. **Control Panel** - This device may be used to monitor auxiliary devices (low-pressure supervisory switch, discharge pressure switch, etc.) as well as any fire detector, warning devices, or alarm/notification devices
10. **Early Warning and Alarm Devices** - Early warning devices maximize system efficiency while audible and visual alarm devices alert staff of alarm conditions.





EQUIPMENT DESCRIPTION

The FM-200[®] agent is stored as a liquid in cylinder assemblies designed specifically for the application and charged to a fill density of between 35 lb/ft³ (561 kg/m³) and 70 lb/ft³ (1121 kg/m³). To ensure optimal performance, each cylinder is superpressurized with dry nitrogen to 360 psi (24.8 bar) at 70°F (21°C). An identification label is affixed to the cylinder body indicating the fill quantity of FM-200[®], charging pressure, date of fill, and fill station. The Lv Series supports three cylinder capacities.

FM-200[®] fire extinguishing systems are designed to be discharged within 10 seconds into a room, area, or enclosure with the structural integrity to retain the agent. The FM-200[®] uniformly mixes throughout the protected area, achieving a minimum concentration level in accordance with NFPA 2001 and/or agency listings.

Nominal Cylinder Size	P/N	Fill Capacity				Empty Weight	
		Minimum		Maximum		lb	kg
		lb	kg	lb	kg		
600 lb	18527	304	137.9	609	276.2	377	171.0
900 lb	18528	455	206.4	910	412.7	494	224.1
1000 lb	18529	561	254.5	1000	453.6	639	289.8

The cylinder assembly is composed of a cylinder, dip tube, cylinder valve, rupture disc, and liquid level indicator.

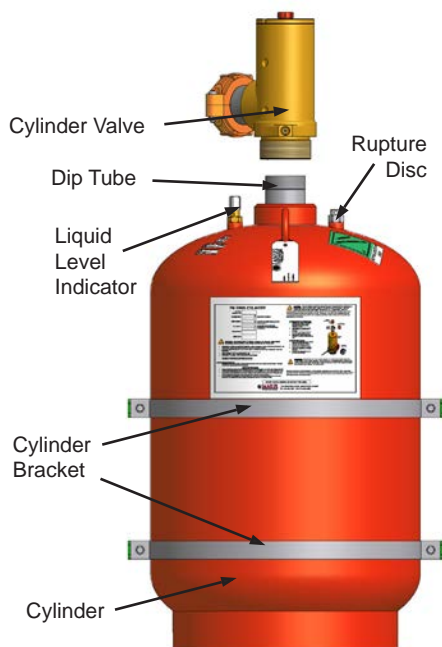

Cylinder Valve: The automatic release of FM-200[®] is controlled by a forged brass, differential pressure operated cylinder valve connected to the neck of the cylinder. The valve assembly is shipped with an anti-recoil safety device installed in the discharge outlet and chained to the cylinder valve.

Dip Tube: A threaded, rigid dip tube extends from the cylinder neck down to its bottom.

Cylinder: The light walled, welded seam cylinder is manufactured according to the requirements of the U.S. Department of Transportation (USDOT) and Transport Canada (TC)¹ for compressed gas. Internal neck threads allow connection of the cylinder valve. The cylinder is designed for mounting in a vertical position only.

Rupture Disc: A frangible rupture disc is fitted to the cylinder body. It functions as an emergency relief device in the event of excessive pressure within the cylinder. Its rupture point is between 850 psi (58.6 bar) and 1000 psi (68.9 bar).

Liquid Level Indicator: A liquid level indicator located on the cylinder body is a nonmagnetic tube containing a measurement tape attached to a magnet. As the tape is removed, the magnet will engage at the liquid surface. This measurement is compared with a chart in the design manual to determine the current fill weight of the cylinder.

¹ 1000 lb Cylinder is not Transport Canada approved, but CAN be used in Canada as they meet 49CFR requirements and are marked DOT.

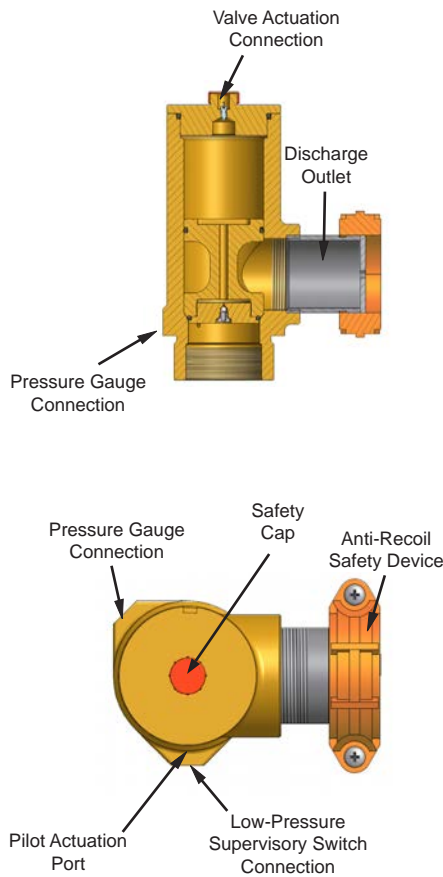

The cylinder valve has five connection points:

Valve Actuation Connection: A threaded connection located on top of the cylinder valve serves as the attachment point for the manual-pneumatic (primary) or pneumatic (secondary) valve actuator.

Pressure Gauge Connection: A female connection serves as the attachment point for the pressure gauge assembly. It is fitted with an internal check valve to allow removal of the pressure gauge assembly while the cylinder is pressurized.

Low-Pressure Supervisory Switch Connection: A female connection serves as the attachment point for the low-pressure supervisory switch assembly. An internal check valve allows for removal of the pressure switch while the cylinder is pressurized.

Discharge Outlet: A 3 in (80 mm) grooved connection serves as the attachment point for discharge piping.

Pilot Actuation Port: A 1/4 in (8 mm) FNPT connection (shipped with a removable plug) provides a means of applying actuation pressure to the secondary cylinder(s). This can also be used for attachment of the discharge pressure switch in single cylinder arrangements. The port is pressurized only during the 10 second discharge period.

CYLINDER MOUNTING

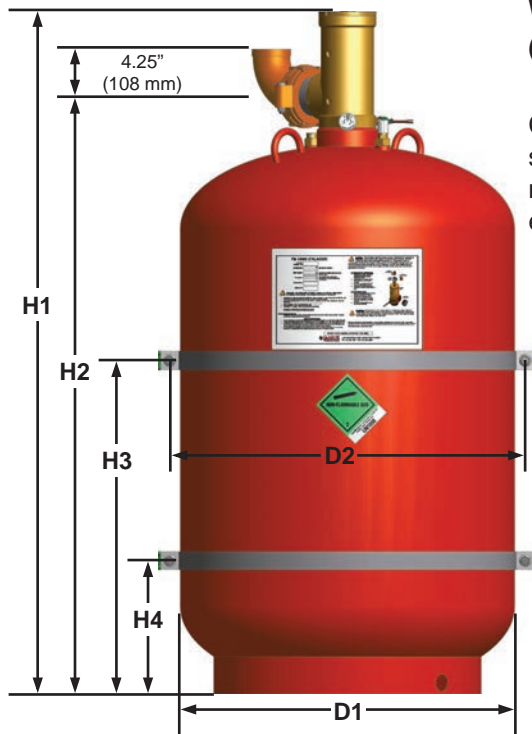

Wall Mount Cylinder Bracket Assembly (P/N See Chart)

Cylinder stability is ensured by the cylinder bracket assembly, consisting of two straps and rails with accompanying bolts, nuts, and washers. The rails are slotted for ease of mounting with fasteners provided by the installer.

	Cylinder Dimensions					
	600 lb		900 lb		1000 lb	
	in	mm	in	mm	in	mm
H1	52.56	1335	69.81	1773	61.83	1559
H2	44.92	1141	62.17	1579	53.73	1365
H3	23.0	584	40.0	1016	30.0	762
H4	12.0	305	20.0	508	13.0	330
D1	24.0	610	24.0	610	30.0	762
D2	25.91	658	25.91	658	31.91	811
P/N	97771		97771		97770	

SYSTEM OPERATION

The Janus Fire Systems® Fire Suppression System for Marine Application may be designed for pneumatic operation or cable pull operation.

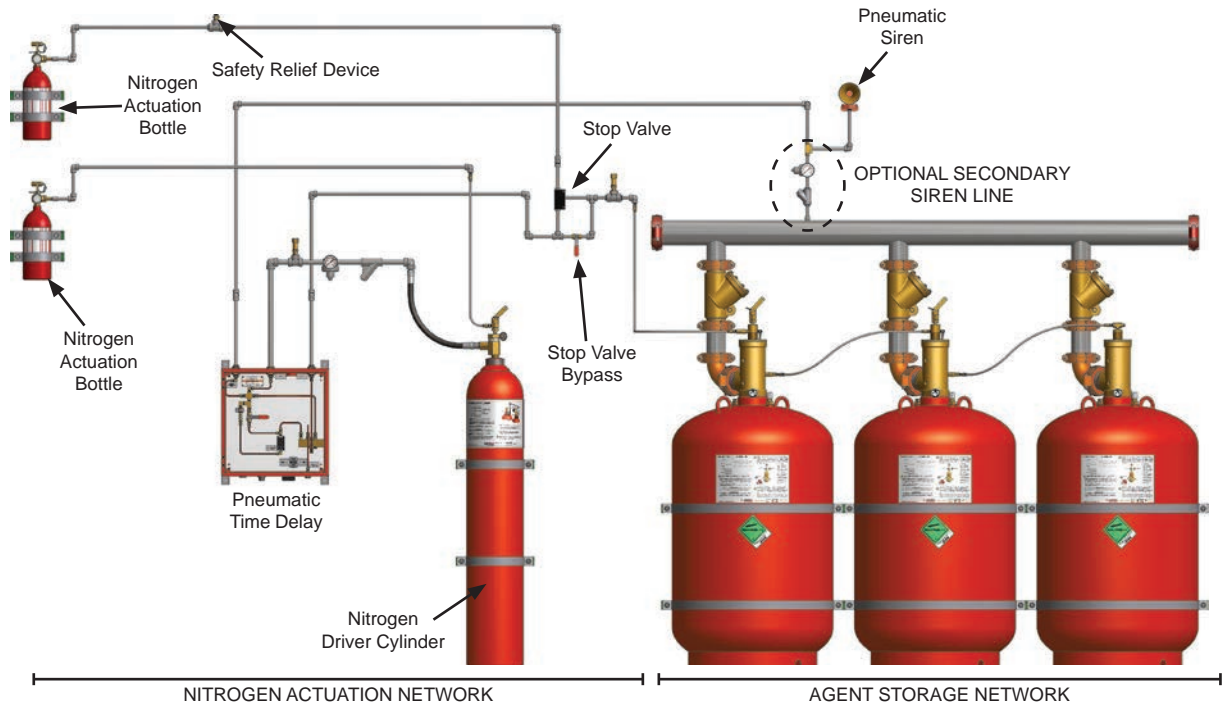

Pneumatic Arrangement

The pneumatic system arrangement utilizes stored nitrogen to actuate the nitrogen driver cylinder that opens the cylinders containing the FM-200®. System actuation is initiated at the small nitrogen actuation bottles. Both bottles must be manually operated before the system can actuate. One bottle will send actuation pressure to open the pilot stop valve while the other will send actuation pressure to open the large nitrogen driver cylinder.

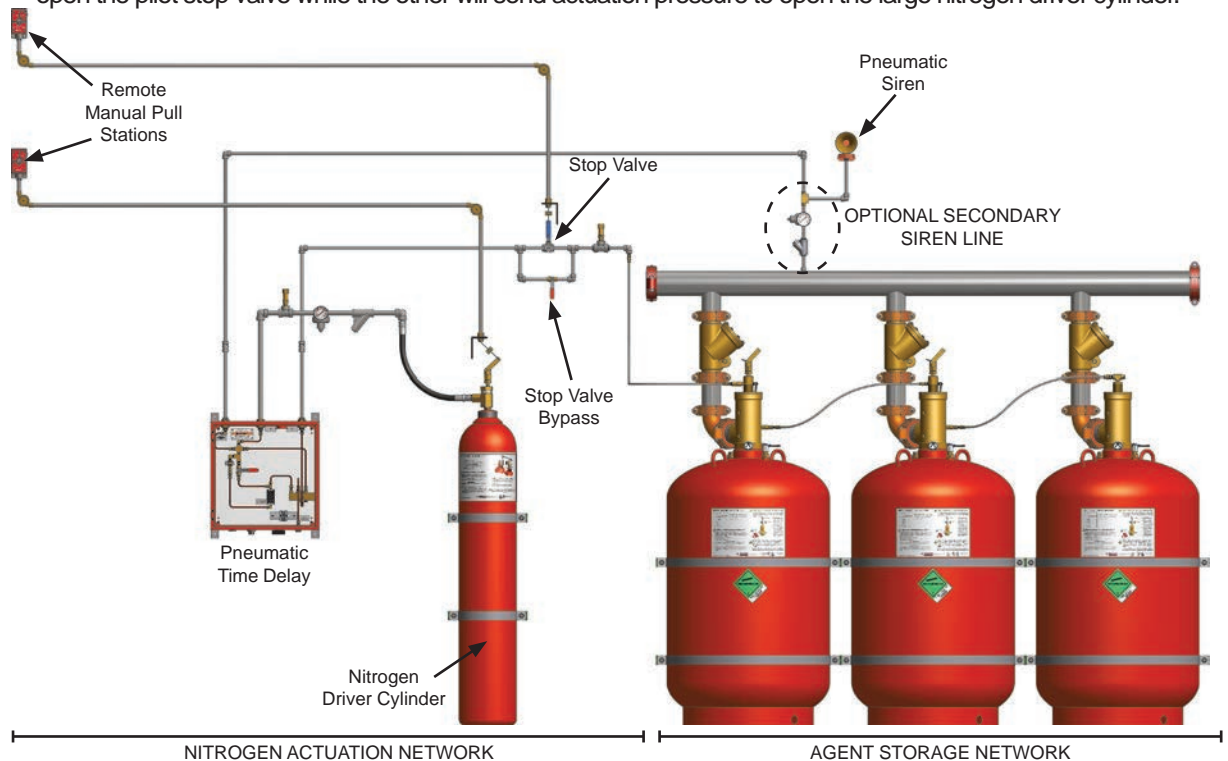

Cable Pull Arrangement

The cable pull arrangement utilizes stored manual pull stations connect to cables that actuate the nitrogen driver cylinder. Two separate manual pull stations must be manually operated before the system can actuate. One station is connected by cable to the pilot stop valve while the other is connect by cable to the emergency actuation lever of open the large nitrogen driver cylinder.



In both system arrangements, once the large nitrogen driver is opened, actuation nitrogen pressure travels from the nitrogen driver cylinder into the timer and siren mechanism after being regulated down to 100 psi (6.89 bar). Once the predischarge period has passed, the pneumatic timer will open sending nitrogen to the nitrogen actuation connection port of the marine cylinder valve actuator via the pilot stop valve. This causes the primary cylinder to open. Any additional cylinders will be actuated by pneumatic pressure passing through the pilot actuation port of the primary cylinder valve.

CYLINDER TRIM COMPONENTS

Trim components are required to operate the clean agent cylinder(s).

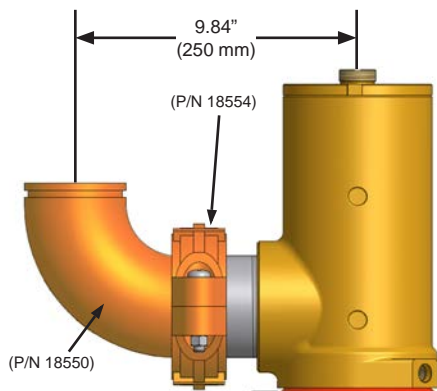
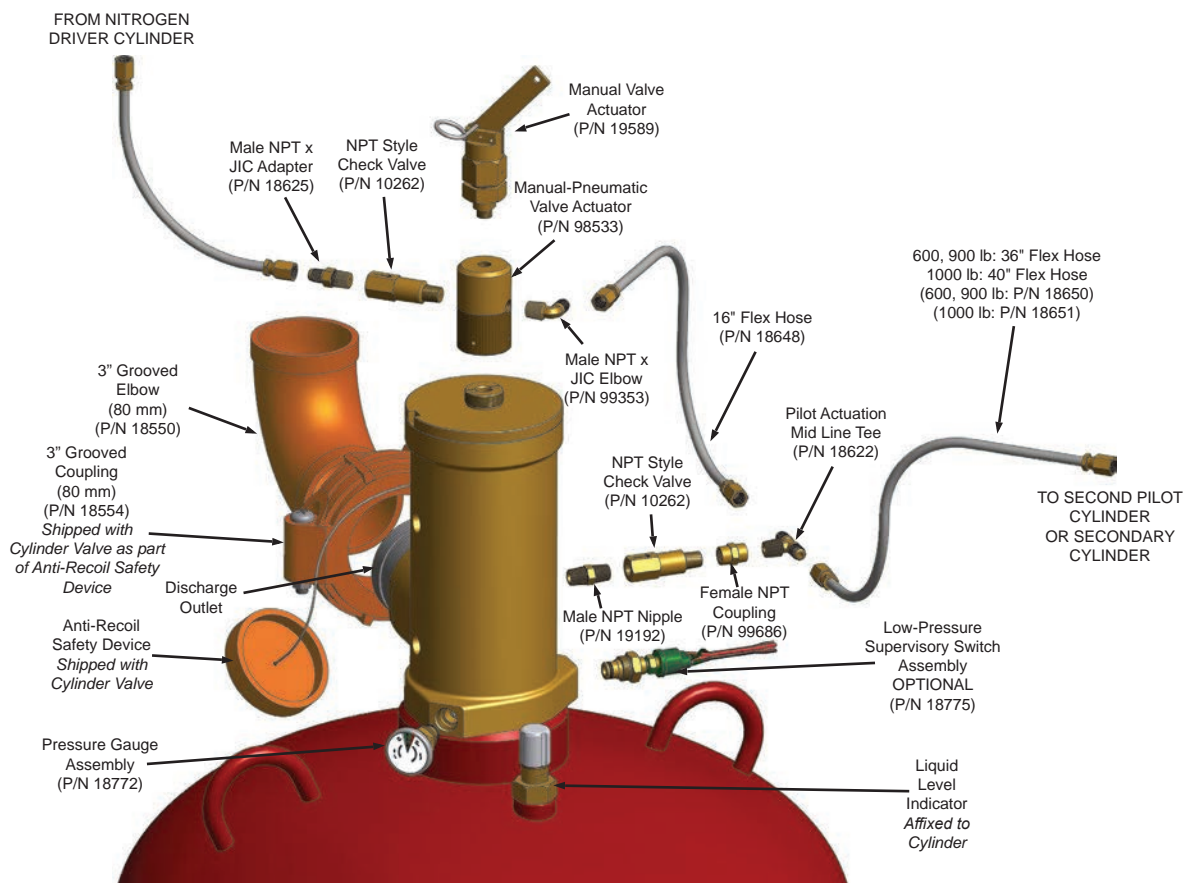

Discharge Connection Fittings (P/N See Diagram)

A 3 in (80 mm) grooved elbow connects to the grooved cylinder outlet adapter utilizing the coupling factory installed to retain the anti-recoil safety device. Pipe and fittings beyond the 3 in (80 mm) elbow are to be supplied by the installer.

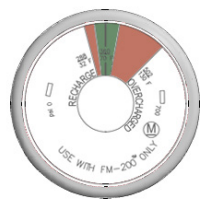

Pressure Gauge Assembly (P/N 18772)

NFPA 2001 mandates a pressure gauge for each cylinder as a method of visually monitoring the internal pressure condition of the cylinder assembly.

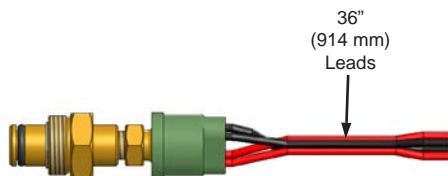

Low-Pressure Supervisory Switch Assembly (P/N 18775)

An optional low-pressure supervisory switch continuously monitors the pressure of the cylinder. The contact configuration is single pole, single throw (SPST) with contacts rated 1.5 Amps at 24 VDC. Should the cylinder pressure drop to approximately 280 psi (19.3 bar), the switch contacts will close transmitting an abnormal signal to a control panel. An optional conduit adapter (P/N 99408) is available for the low-pressure supervisory switch to facilitate the attachment of rigid or flexible conduit over the switch leads. An explosion-proof switch assembly is also available (P/N 98660).

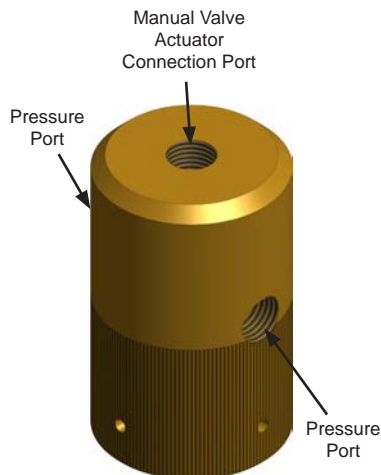

Marine Cylinder Valve Actuator (P/N 98533)

The manual-pneumatic valve actuator attaches to the valve actuation connection of each primary clean agent cylinder. The manual valve actuator is installed into the top of the manual-pneumatic valve actuator. On the first primary valve in a system requiring two primary valves, one pressure port of the manual-pneumatic actuator is connected to the nitrogen driver actuation network while the other port is attached to the pilot actuation network for the additional cylinders. Nitrogen pressure from the driver actuation network, actuation of the manual valve actuator, or pilot pressure from a secondary primary cylinder that has been manually actuated will cause the pin inside the manual-pneumatic actuator to open the clean agent cylinder valve.

On the second primary cylinder, one port of the manual-pneumatic is connected to the manual-pneumatic valve actuator of the first primary cylinder and the other to the pilot actuation network of the remaining cylinders.

If there are no secondary cylinders at all, one port of the manual-pneumatic valve actuator is connected to the nitrogen actuation network and the other has a vent check installed in it.

Manual Valve Actuator (P/N 19589)

A manual valve actuator attaches to the manual actuation port on top of the nitrogen driver cylinder valve as well as the manual/pneumatic actuator on the clean agent cylinder valve. It provides a means for emergency manual actuation of the cylinder valve. The manual valve actuator consists of a brass body, emergency release lever, pressure port, and steel safety ring pin.

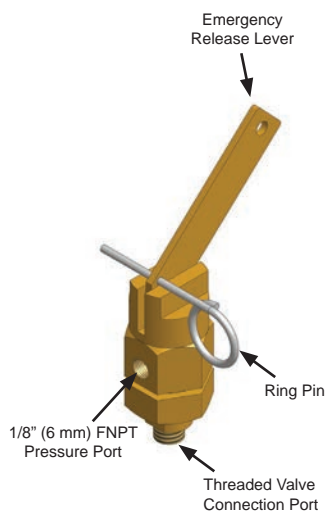

In the pneumatic arrangement, pressure from a remote nitrogen actuation bottle enters the pressure port of the manual valve actuator on the nitrogen driver, causing the actuation pin inside the valve actuator to depress the Schrader valve inside the manual actuation port of the nitrogen drive cylinder valve, causing pressure above the drive cylinder valve piston to be vented. Cylinder pressure then raises the piston to open the cylinder valve.

In the cable-pull arrangement, the emergency release lever of the manual valve actuator installed on the nitrogen driver is connected by cable to a remote cable-pull station. Operating the cable-pull station causes the emergency release lever to be tripped, resulting in the actuation pin being depressed and the cylinder valve opening as described in the preceding paragraph.



NITROGEN ACTUATION COMPONENTS

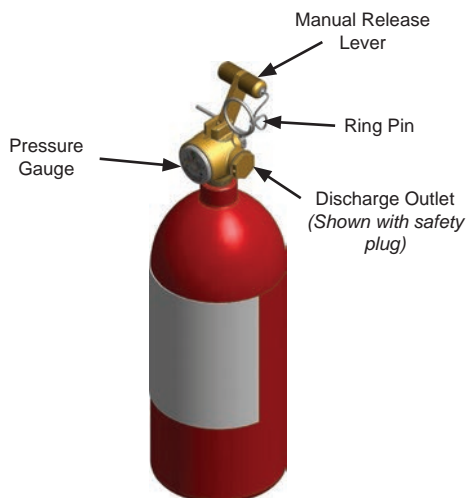

Remote Nitrogen Actuation Bottle

In pneumatic arrangements, two small nitrogen actuation bottles are installed at the remote end of the system. One is used to initiate the pneumatic timer sequence via the large nitrogen driver cylinder. The other opens the pneumatic stop valve to allow nitrogen actuation pressure to reach the clean agent cylinder once the pre-discharge delay has passed. Both must be operated to cause the system to discharge.

Nitrogen is stored in the actuation bottle at a pressure of 1,800 psi (124 bar) at 70°F (21°C). To actuate the nitrogen bottle, the ring pin is removed and the manual release lever is pulled.

The nitrogen actuation bottles can be provided in individual enclosure cabinets, in a single enclosure cabinet containing both required bottles, or individually without any enclosure at all.

P/N	Mounting Style
26101	Single Bottle - No Enclosure (Requires Bracket Kit P/N 97769 and CGA 580 Connection P/N 97987 ordered separately)
97985	Single Bottle - Single Cabinet NEMA 4 & 12 Enclosure (Order bottle separately)
97984	Two Bottles - Single Cabinet NEMA 4 & 12 Enclosure (Order bottles separately)

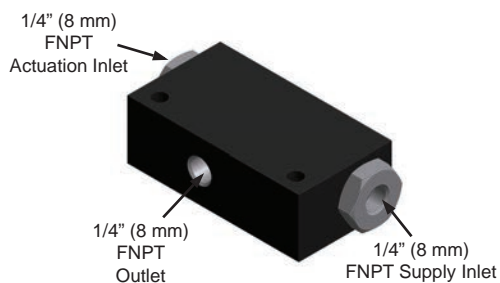

Pneumatic Stop Valve (P/N 99766)

A three-way pilot valve acts as the pneumatic stop valve for the Pneumatic Actuation arrangement. It has a standalone ambient temperature range of -40° to 300°F (-40° to 149°C) and is rated for an operating pressure of 3000 psi (207 bar). The valve body is aluminum with a stainless steel piston.



Header Safety Device (P/N 19598)

This pressure relief device is installed in sections of closed piping under high pressures such as between nitrogen actuation bottle and pneumatic stop valve. It is a frangible disc assembly designed to rupture if trapped N2 expands and the line pressure exceeds 2,650 to 3,000 psi (182.7 to 206.8 bar). The body is made of brass and the pipe connection is 1/2 inch (15 mm) MNPT.

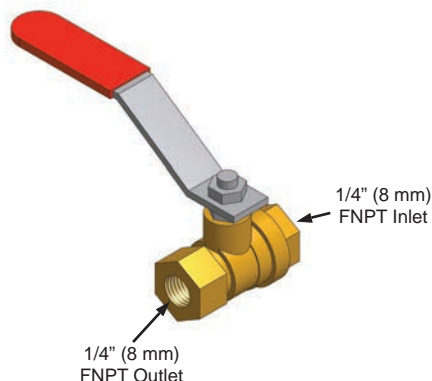

Manual Stop Valve Bypass (P/N 19173)

In all arrangements, a manual stop valve bypass is installed in the nitrogen actuation network downstream of the pneumatic time delay cabinet so that when opened, the nitrogen driver pressure would actuate the clean agent system immediately following the completion of the time delay without the pneumatic or cable pull stop valve being actuated. The manual stop valve bypass is a manually actuated full port ball valve made of forged brass with reinforced PTFE seats and seals and have 1/4 in (8 mm) FNPT connections. The standalone ambient temperature range for the valve is -20° to 130°F (-29° to 54°C).



CABLE-PULL ACTUATION COMPONENTS



CAUTION

Removing the ring pin from the manual valve actuator will create the potential for accidental manual discharge.

Remote Manual Pull Station, Watertight (P/N 97722)

In Cable Pull arrangements, one remote manual pull station is connected by a system of cables and pulleys to the emergency release lever installed on the nitrogen driver cylinder while a second connected to a manual release on the pilot stop valve. Both must be operated to actuate the system. Both stations must be pulled to actuate the system.

The pull station has a 3/8 in (10 mm) FNPT connection and is used with 3/8 in (10 mm) Schedule 40 pipe. Removing the safety pin and pulling the handle of the remote manual pull station will mechanically actuate the connected apparatus.

The remote manual pull station requires a travel distance of 2 in (51 mm) to actuate the system. Manual pull stations should be located in a path of egress and mounted at a height conforming with the local authority having jurisdiction.

NOTE: When a manual pull station is to be implemented in a system, any ring pins on the connected apparatus **MUST** be removed prior to arming the fire extinguishing system. Failure to remove the ring pin will prevent the remote manual (cable) pull station from actuating the system.

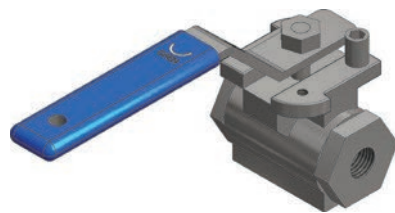

Cable Pull Stop Valve (P/N 97711)

A 1/4 in (8 mm) manually actuated ball valve with specially designed handle acts as the stop valve in cable pull arrangement. Cable is affixed to the handle so that the valve is opened when the connected remote cable pull station is actuated.

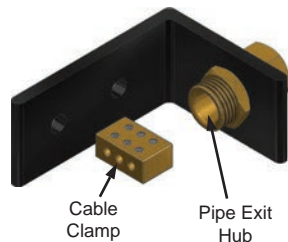

Conduit to Cable Exit Fitting (P/N 97751)

The cable exit fitting is install at the end of the cable pipe run nearest the manual valve actuator. It is used to minimize the friction on the cable when the system is actuated via the cable pull system. A cable clamp is used to secure the cable when it is affixed to the emergency release lever of the manual valve actuator. The cable exit fitting has one 3/8 in (10 mm) FNPT connection.



Dual Pull Cable Operator (P/N 97758)

The dual pull cable operator is used to allow two manual pull stations to actuate a single device. The operator has three 3/8 in (10 mm) FNPT connections and is used with 3/8 in (10 mm) Schedule 40 pipe.

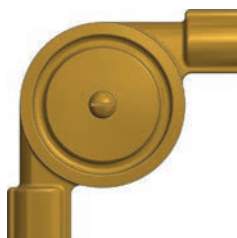

Corner Pulley (P/N 97765)

Corner pulleys are used to change direction of cable by 90 degrees. Corner pulleys have two 3/8 in (10 mm) FNPT connections and are used with 3/8 inch (10 mm) Schedule 40 pipe.

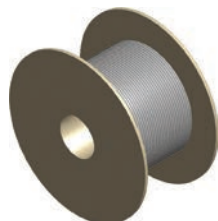

Cable (P/N 12553)

Cable is used to run from the manual valve actuator, through pipe and corner pulleys to manual pull stations. The cable is 1/16 inch diameter stainless steel (7x7 - 480# tensile strength) and is shipped in 500 foot (152 m) spools.



NITROGEN DRIVER COMPONENTS

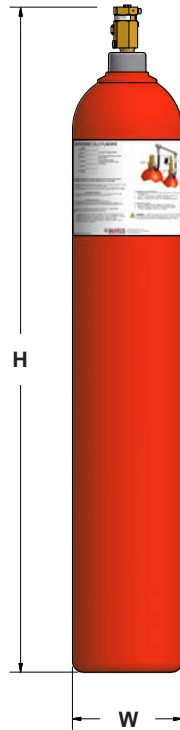

Nitrogen Driver Cylinder Assembly

The large nitrogen driver cylinder assembly is installed upstream of the pneumatic time delay cabinet and pilot stop valve. Upon being actuated via the remote nitrogen actuation bottle or remote cable pull station, it opens sending nitrogen to the pneumatic timer cabinet.

The nitrogen driver cylinder is pressurized to 1,800 psi (124.1 bar) at 70°F (21°C). It is composed of a cylinder and cylinder valve.

Cylinder Valve: The automatic release of nitrogen is controlled by a forged brass, force differential operated cylinder valve connected to the neck of the cylinder. Each valve assembly is shipped with an anti-recoil safety plug installed in the discharge outlet and a manual actuation safety plug installed in the manual actuation connection. Both safety plugs are chained to the cylinder valve.

Cylinder: The seamless cylinder is manufactured according to the requirements of the U.S. Department of Transportation (USDOT) and/or Transport Canada for compressed gas. The cylinder is designed for mounting in a vertical position only.

Nominal Cylinder Size ¹		P/N	Height (H)		Width (W)		Cylinder Bracket P/N
L	in ³		in	mm	in	mm	
39.1	2,386	26093	55.6	1412	8.5	216	97768
50.0	3,051	26094	61.1	1552	9.2	234	97767
66.7	4,070	26095	62.6	1590	10.4	264	97766

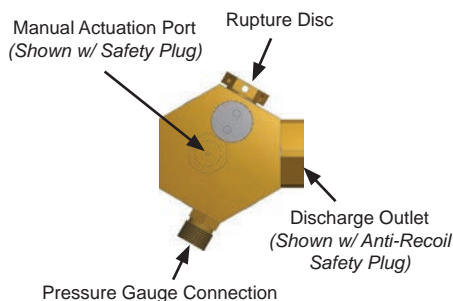
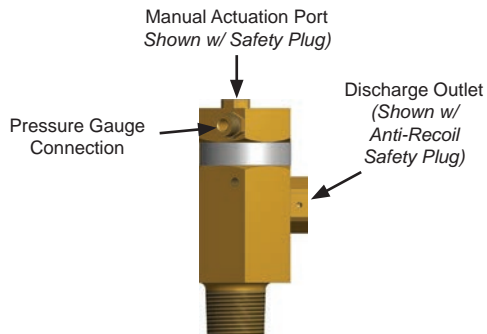

The driver cylinder valve has the following key features:

Manual Actuation Port: A threaded female connection on the top of the primary valve serves as the attachment point for the manual valve actuator. It is shipped with a manual actuation safety plug installed.

Supervisory Connection Port: A threaded male connection serves as the attachment point for the supervisory pressure switch/pressure gauge assembly.

Discharge Outlet: A 1-1/16" threaded female connection serves as the attachment point for the discharge outlet adapter or discharge check valve. It is shipped with an anti-recoil safety plug installed.

Rupture Disc: A rupture disc is affixed to the cylinder valve as an emergency relief device in the event of excessive pressure within the cylinder. Its rupture point is in the range of 2,650 to 3,000 psi (182.7 to 206.8 bar).

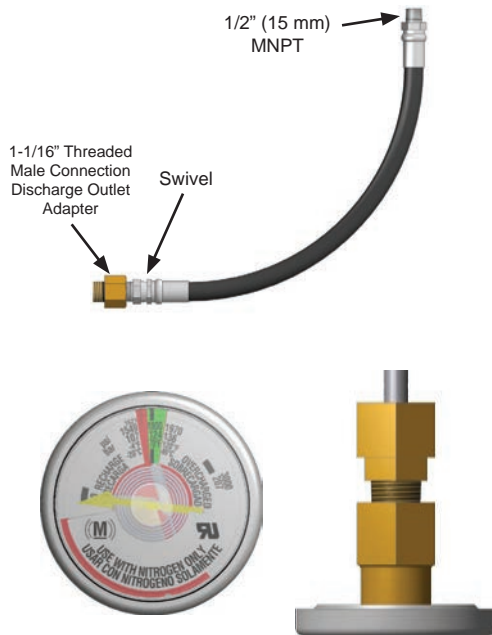

Discharge Flex Hose w/ Discharge Outlet Adapter (P/N 99707)

A 22 in (559 mm) discharge flex hose is used to connect the nitrogen driver cylinder flex valve outlet to the system manifold and discharge piping. The flexible hose allows for temporary misalignment of the cylinders to ease installation or removal for maintenance. It has a minimum bend radius of 9.5 inches (241 mm). It is shipped with a discharge outlet adapter to facilitate the attachment of the discharge flex hose to the cylinder valve.

N₂ Pressure Gauge Assembly (P/N 26096)

A pressure gauge is field installed on the nitrogen driver cylinder to provide a reliable means of monitoring the internal pressure within the cylinder. It is fitted with an adapter that allows the gauge to be connected to the nitrogen driver cylinder valve at the pressure gauge connection port. An optional combination pressure gauge/low-pressure supervisory switch (P/N 26098) is available that may be installed in place of the standard pressure gauge. The gauge/switch combination has 35 in (889 mm) leads.

COMMON ACTUATION COMPONENTS

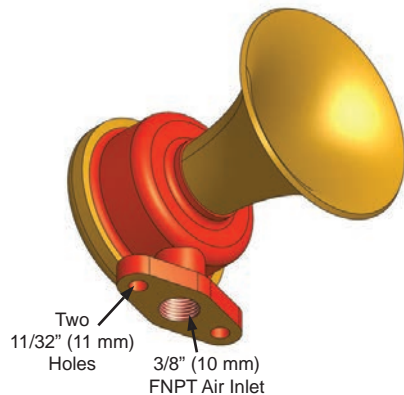

Pneumatic Siren (P/N 19224)

A pneumatic siren is installed downstream of the siren outlet of the time delay cabinet so that it is sounded during the pre-discharge period as required by NFPA 12. Each siren has a solid cast bronze bell with a stainless steel diaphragm and reaches a sound level of 119 ± 1DBA @ 100 psi at 10 ft (3.05 m). Each siren uses 1.3 lbs/minute (0.49 kg/minute) and has a C_v of .25. The sirens have an operating pressure of 50 to 150 psi (3 to 10 bar) and a standalone ambient temperature range of -4° to 400°F (-20° to 204°C).

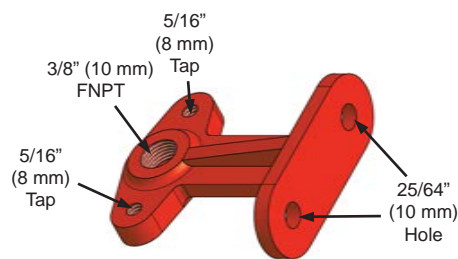

Pneumatic Siren Bracket (P/N 19225)

A pneumatic siren bracket affixes to the base of each pneumatic siren to allow the siren to be fastened to an outside surface.

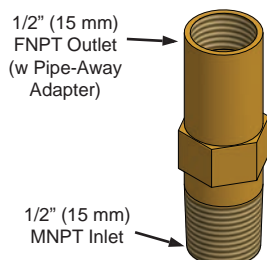

Pressure Relief Valve (P/N 19316)

A pressure relief valve must be installed in the nitrogen actuation piping at any point downstream of the regulator where pipe may be closed off. Each relief valve has a 0.062 in² (40 mm²) orifice area and is set to open should line pressure exceed 125 psi (8.62 bar). Each relief valve has a brass body with a stainless steel spring and a standalone ambient temperature range of -320°F to 165°F (-196°C to 74°C). A pipe-away adapter (P/N 19318) is available to convert the outlet to a 1/2" (15 mm) FNPT connection.

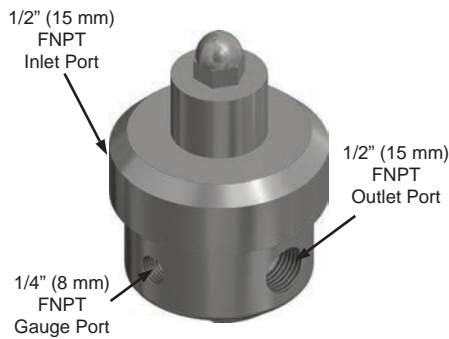

High Pressure Regulator (P/N 99772)

A 316L stainless steel self-relieving pressure regulator with Teflon seat is utilized to regulate nitrogen pressure into the pneumatic time delay cabinet. It has a 1/2 in (15 mm) FNPT inlet and outlet with a maximum operating inlet pressure of 3600 psig (248 bar) and an outlet range of 0 to 250 psig (0 to 17.2 bar). The regulator has a stand-alone ambient temperature range of -4° to 176°F (-20° to 80°C) and a Cv of 1.0. A pressure gauge (0-160 psig P/N 19171) may be fastened to the regulator to allow visual monitoring of outlet pressure.



High Pressure Y Strainer (P/N 98656)

A 1/2" (15 mm) strainer is used to eliminate damaging contaminants from entering the high pressure regulator or time delay cabinet. The "Y" pattern design and generous screen area function to minimize initial pressure drop while maximizing time between cleaning. The strainer is stainless steel and is provided with a 40 mesh lining. The connections are FNPT. Strainer rating is ASME class 1500. Drain/blow off connection is furnished with plug.

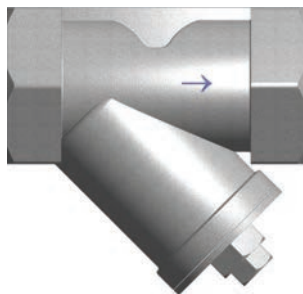

Siren Line Strainer (P/N 19370)

A 1/2 in (15 mm) strainer is installed upstream of the siren pressure regulator to prevent debris from entering the regulator or pneumatic siren. The body and screen are stainless steel. The internal filter has a size of 40 mesh. The strainer is rated ASME class 300.

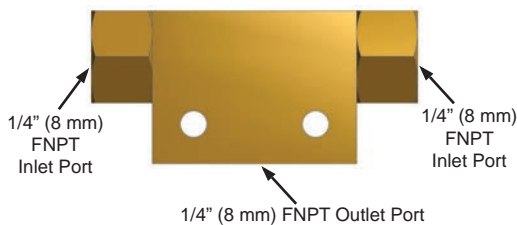

Siren Shuttle Valve (P/N 99767)

The siren shuttle valve is installed upstream of the pneumatic siren. It either receives pressure from the nitrogen actuation line during a standard system actuation or discharge pressure during an emergency manual cylinder actuation and directs this pressure to the pneumatic siren. The siren shuttle valve has a standalone ambient temperature range of -300° to 450°F (-184° to 232°C) and is rated for an operating pressure of 3000 psi (207 bar).



Siren Pressure Regulator (P/N 19599)

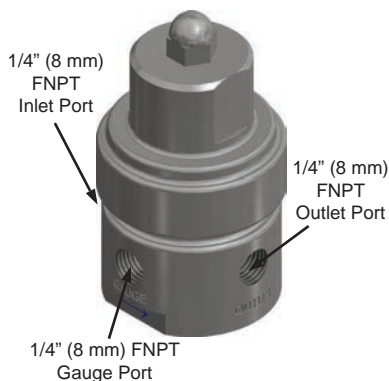

A 316L stainless steel self-relieving pressure regulator with Teflon seat is utilized to regulate pressure coming off the discharge manifold or discharge piping to the pneumatic siren. It has a 1/4 in (8 mm) FNPT inlet and outlet with a maximum operating inlet pressure of 3600 psig (248 bar) and an outlet range of 0 to 250 psig (0 to 17.2 bar). The regulator has a standalone ambient temperature range of -40° to 500°F (-40° to 260°C) and a Cv of 0.5. A pressure gauge (0-160 psig P/N 19171) may be fastened to the regulator to allow visual monitoring of outlet pressure. The high pressure regulator (P/N 99772) is to be used for applications that require a higher Cv (e.g. where more than two sirens are being implemented from the same pilot cabinet or line.)

PNEUMATIC TIME DELAY CABINET

Enclosure

NEMA 4 & 12 (IP66)
 Heater Included
 Dimensions: 20" x 20" x 6"
 (508 mm x 508 mm x 152 mm)
 Standalone Ambient Temp: -20° to 130°F (4° to 54°C)
 (NOTE: 40°F to 130°F without Heater)

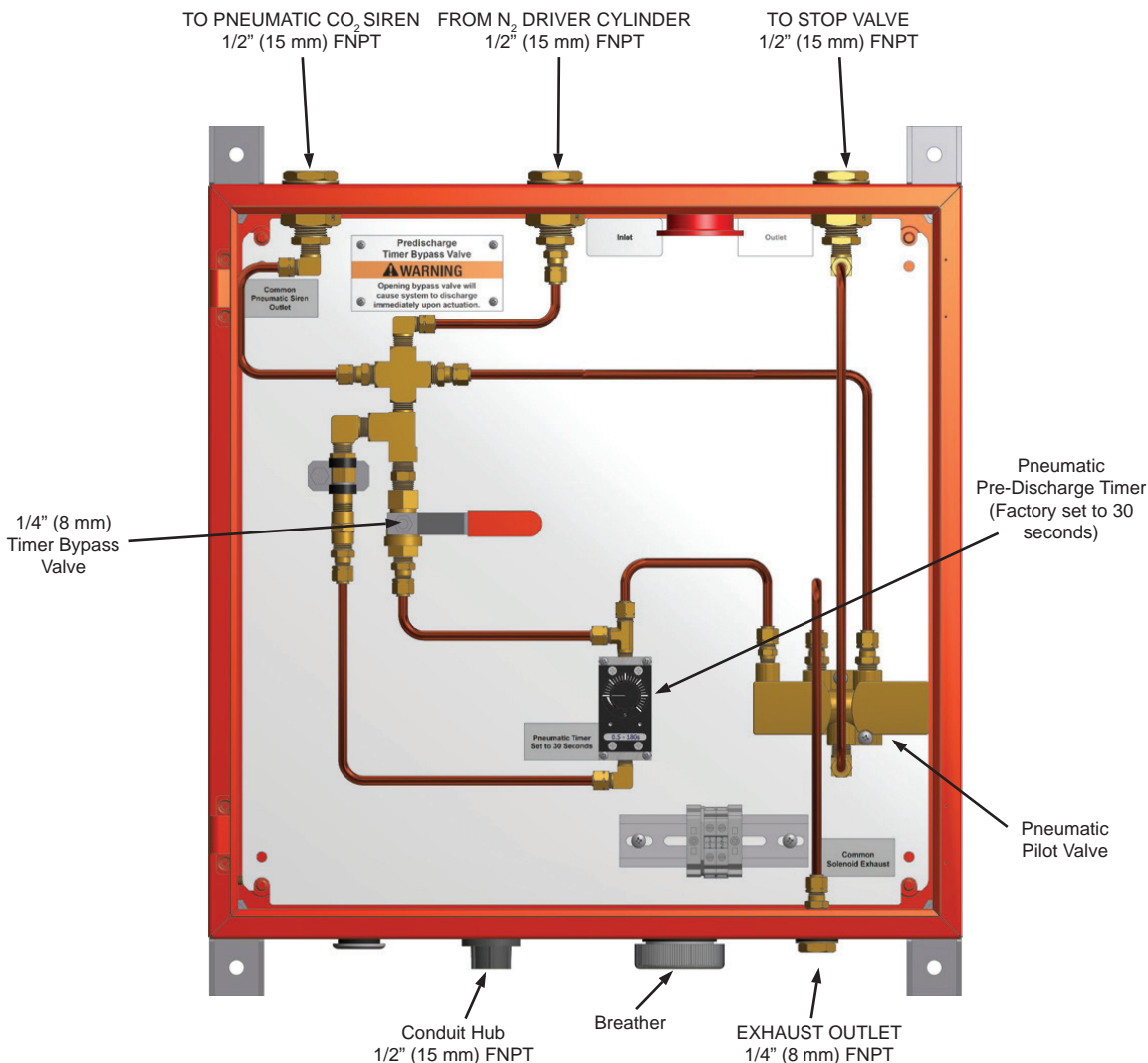

Standard Marine Time Delay Cabinet (P/N 97691)



MULTI-CYLINDER ARRANGEMENT COMPONENTS

Up to 16 cylinders (1 primary and 15 secondary) may be installed in a single arrangement, with a maximum length of 100 ft (30.48 m) of pilot actuation hose or tubing extending from the primary cylinder in either direction. A typical arrangement is shown below.

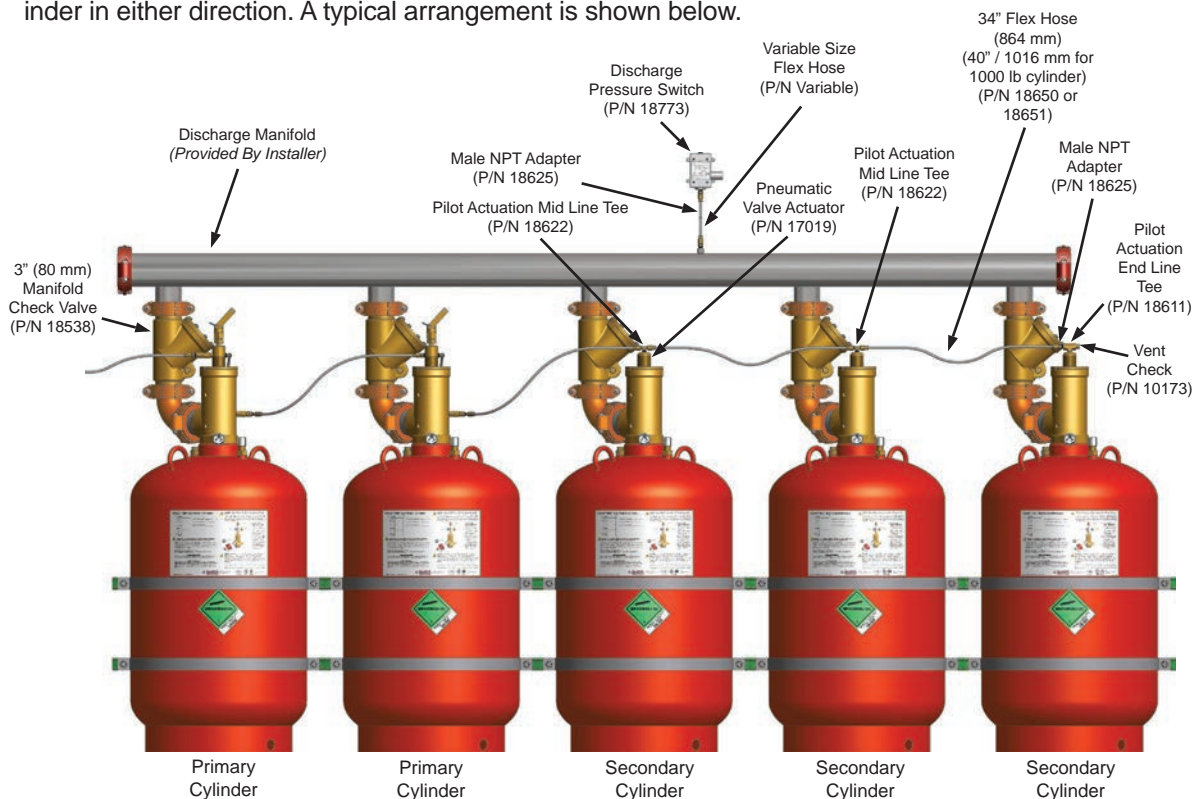

Typical Primary and Secondary Cylinder Arrangement

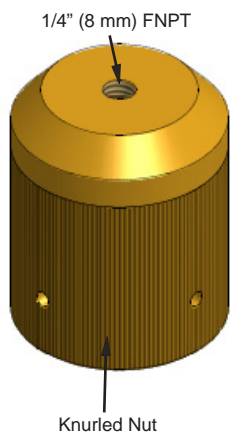

Pneumatic Valve Actuator (P/N 17019)

On multiple cylinder systems, nitrogen actuation pressure from the driver cylinder enters the manual marine actuator causing the primary cylinder(s) to open and then, in a rapidly occurring sequence, the pneumatic valve actuator(s) will open all other cylinders using pressure from the primary cylinder.

A pneumatic valve actuator attaches to the valve actuation connection of each secondary cylinder. It receives pressure from the pilot actuation port of the primary cylinder through the pilot actuation check valve. It is brass with a brass piston and pin.

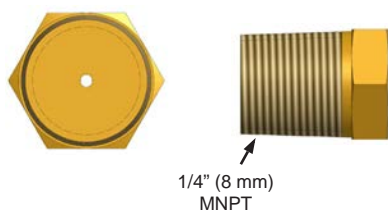

Vent Check (P/N 10173)

The vent check is a safety device with 1/4 in (8 mm) MNPT threads that is to be installed in the pilot actuation line downstream of the pilot actuation check valve. It is used to bleed off pressure that may accumulate in the pilot actuation hose or piping minimizing the chance of inadvertent pressurization of the pneumatic actuators or discharge pressure switch.

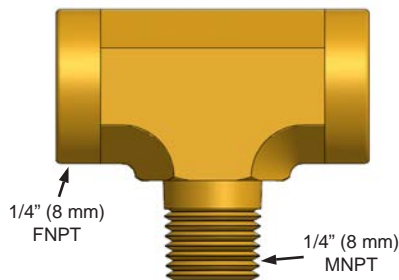
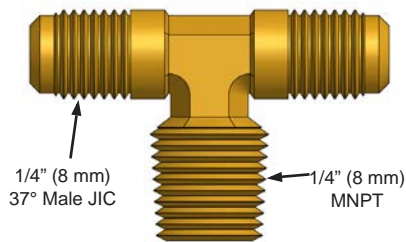

Various adapter fittings are required to accommodate the attachment of the pilot actuation check valves, tees, flex hose, and actuators. The list below includes part numbers and descriptions for all the commonly supplied fittings. All fittings are brass.

P/N	Type	Fitting
18625	Nipple	1/4" (8 mm) 37° JIC male x 1/4" (8 mm) MNPT
19192	Nipple	1/4" (8 mm) MNPT x 1/4" (8 mm) MNPT
99686	Coupling	1/4" (8 mm) FNPT x 1/4" (8 mm) FNPT
99353	Elbow	1/4" (8 mm) 37° JIC male x 1/4" (8 mm) MNPT
18624	Bushing	3/8" (10 mm) MNPT x 1/4" (8 mm) FNPT

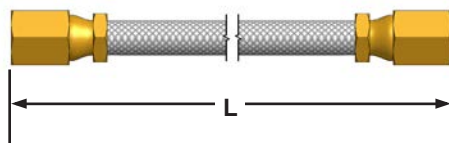

P/N	Hose Length (L)
18648	16 in (406 mm)
18649	24 in (610 mm)
18650	34 in (864 mm)
18651	40 in (1016 mm)

NPT Style Pilot Actuation Check Valve (P/N 10262)

The NPT Style Check Valve is a 1/4 in (8 mm) FNPT by MNPT check valve. It is installed at the immediate end of the nitrogen actuation network with direction of flow IN to the manual-pneumatic actuator of the first primary cylinder to ensure the manual-pneumatic actuator remains pressurized through the entire discharge period. One check valve is installed in the pilot pressure port of each primary cylinder with direction of flow OUT of the cylinder to ensure pressurization of the pilot actuation line. Adapters will be required depending on the location of use

Pilot Actuation Mid Line Tee (P/N 18622)

A 1/4 in (8 mm) 37° male JIC by MNPT brass branch tee is utilized to attach the pilot actuation line to the pneumatic valve actuator on all but the final secondary cylinder. On systems requiring two primary cylinders, one tee is also installed downstream of the pilot actuation port immediately after the pilot actuation check valves.

Pilot Actuation End Line Tee (P/N 18611)

A 1/4 in (8 mm) FNPT by MNPT brass branch tee mounts to the final pneumatic valve actuator to facilitate attachment of the vent check to the pilot actuation line.

Flex Hose (P/N See Chart)

Flex hoses are 3/16 in (7 mm) Teflon® lined stainless steel wire braided hoses of varying lengths with 1/4 in (8 mm) 37° female JIC flare fittings. They are utilized to interconnect cylinders when a multi-cylinder arrangement is required. A 1/4 in (8 mm) 37° male JIC flare x male JIC flare adapter (P/N 18777) is available to connect lengths of flex hose together.



SUPPLEMENTAL COMPONENTS

Supplemental components complete various system arrangements.

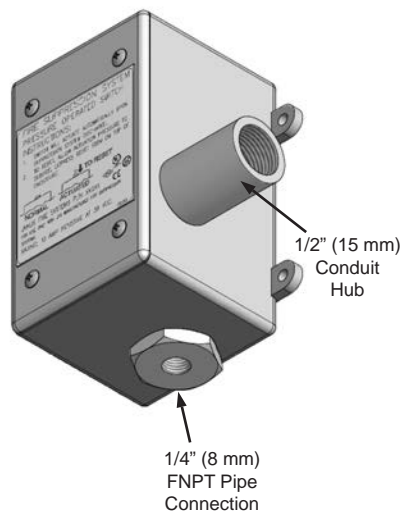

Discharge Pressure Switch (P/N 18773)

The discharge pressure switch is used in the system to provide positive indication of agent discharge and to initiate the shut down of equipment that may deplete agent concentration. The pressure switch is a single pole, double throw (SPDT) switch with contacts rated 10 Amps resistive at 30 VDC.

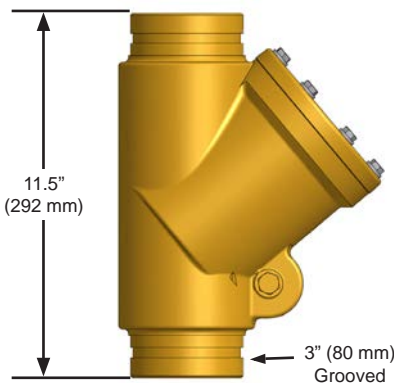

Manifold Check Valve (P/N 18538)

In a multiple cylinder arrangement where the secondary and primary cylinders share a common manifold or in a main / reserve arrangement, a 3 in (80 mm) grooved manifold check valve must be placed between the discharge outlet of each cylinder and the discharge manifold to prevent back flow from the manifold should the system be inadvertently discharged when one or more cylinders are disconnected for maintenance.



Clean Agent
Warning Sign -
Exit (P/N 18489)



Clean Agent
Warning Sign -
Entrance (P/N 18770)

Warning Signs

Warning signs are placed at all entrances to and inside the protected area. Optional Spanish or combination Arabic/English versions of each sign are available.

DISCHARGE NOZZLES

Discharge nozzles (2 or 4 ports) are used to uniformly distribute the FM-200® agent. They are performance tested to ensure that the agent is discharged within 10 seconds and properly dispersed throughout the protected area. Maximum nozzle height for a protected space is 16 ft (4877 mm) per tier of nozzles. Additional tiers are required for heights greater than 16 ft.

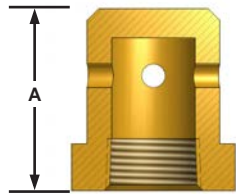

Discharge Nozzle
Cut View



Discharge Nozzle
Top View

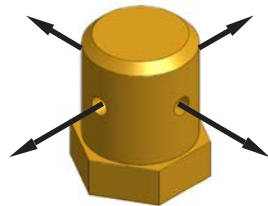

360° Radial Nozzle (4 Port)

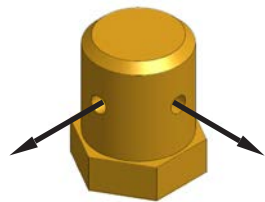

180° Sidewall Nozzle (2 Port)

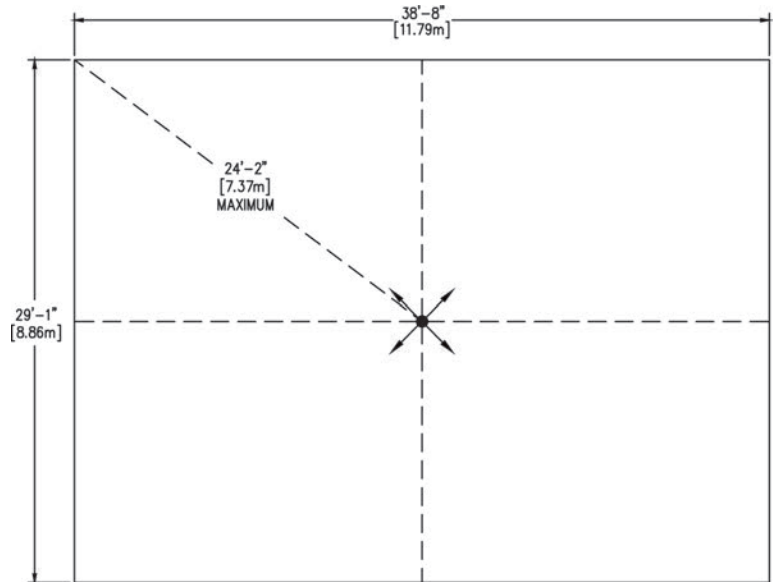

360° Radial Nozzle (4 Port)
Arrangement

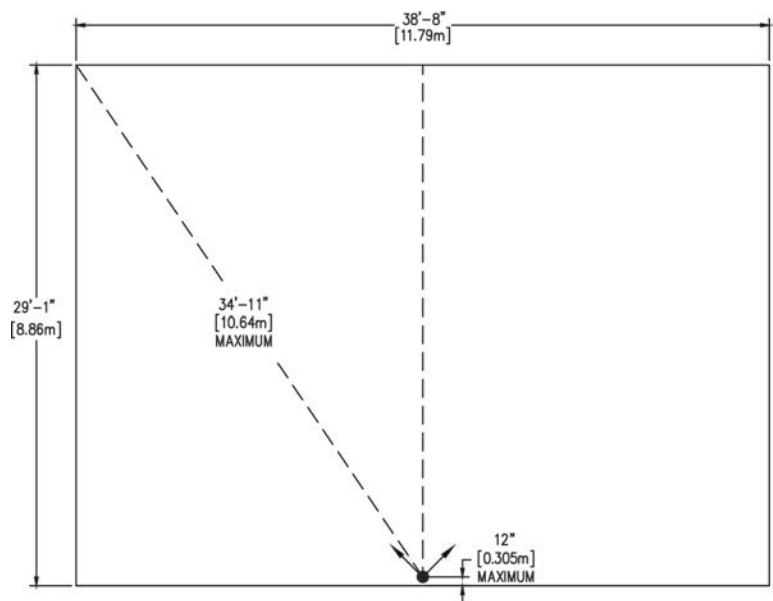

180° Sidewall Nozzle (2 Port)
Arrangement

Note: The spacing limitations for Janus Fire Systems nozzles shown above are those for a marine environment. The limitations are different when used in a standard industrial environment.



Nozzle Orientation Part Number				Nominal Pipe Size	Nozzle Height (A)	
Brass		Stainless Steel			in	mm
360°	180°	360°	180°			
18507	18500	18796	18789	3/8 in (10mm)	1.436	36.5
18508	18501	18797	18790	1/2 in (15 mm)	1.722	43.7
18509	18502	18798	18791	3/4 in (20 mm)	1.926	48.9
18510	18503	18799	18792	1 in (25 mm)	2.176	55.3
18511	18504	18800	18793	1 1/4 in (32 mm)	2.500	63.5
18512	18505	18801	18794	1 1/2 in (40 mm)	2.689	68.3
18513	18506	18802	18795	2 in (50 mm)	3.100	78.7

Ordering Instructions: Specify the Nozzle P/N followed by a dash and the three digits representative of the drill code as provided by the Janus Design Suite® software.
 Example: 18507-XXX = Nozzle: 360°, 3/8" (10 mm), Brass (with drill code as specified)

FM-200® CHEMICAL PROPERTIES

FM-200® (HFC-227ea) is formed from the elements carbon, fluorine and hydrogen (CF₃CHF₂CF₃ - heptafluoropropane). The primary extinguishing mechanism of FM-200® is heat absorption, with a secondary chemical contribution from the thermal decomposition of FM-200® in the flame.

FM-200® leaves no residue and is safe for use in occupied spaces.

Most common metals, such as aluminum, brass, steel, cast iron, lead, stainless steel, and copper, as well as rubber, plastic, and electronic components, are unaffected when exposed to FM-200®.

SAFETY CONSIDERATIONS

Although the EPA Significant New Alternative Program (SNAP) lists FM-200® as acceptable for occupied spaces, NFPA Standard 2001 and SNAP list the following guidelines for human exposure:

The discharge of FM-200® into a hazard may reduce visibility for a brief period. FM-200® may cause frostbite if liquid discharge or escaping vapor contacts the skin.

When FM-200® is exposed to temperatures greater than 1300°F (700°C), the by-product Hydrogen Fluoride (HF) will be formed. FM-200® systems are designed to discharge in 10 seconds or less in order to minimize the amount of HF formed.

The FM-200® Material Safety Data Sheet (MSDS) should be read and understood prior to working with the agent.

A cylinder containing FM-200® should be handled carefully. **The anti-recoil safety device must be in place at all times when the cylinder is not connected to the discharge piping and restrained.**

Time for Safe Human Exposure at Stated Concentrations for FM-200® (HFC-221ea)		
FM-200® Concentration		Maximum Human Exposure Time (Minutes)
% v/v	ppm	
9.0	90,000	5.00
9.5	95,000	5.00
10.0	100,000	5.00
10.5	105,000	5.00
11.0	110,000	1.13
11.5	115,000	0.60
12.0	120,000	0.49

Notes:

1. Data derived from the EPA-approved and peer-reviewed PBPK model or its equivalent.
2. Based on LOAEL of 10.5% in dogs.

Equipment List - Clean Agent Storage and Distribution

P/N	Description	Nominal Wt. lb (kg)	Ship (kg)
18527 ¹	Cylinder Assembly, FM-200, 600 lb (304 to 609 lb capacity / 137.9 to 276.2 kg)	377	(171.0)
18528 ¹	Cylinder Assembly, FM-200, 900 lb (455 to 910 lb capacity / 206.4 to 412.7 kg)	494	(224.1)
18529 ¹	Cylinder Assembly, FM-200, 1000 lb (561 to 1000 lb capacity / 254.5 to 453.6 kg)	639	(289.8)
FM200AGENT	FM-200® Bulk	Variable	
97771	Bracket Assembly, Cylinder, Marine (600 lb / 900 lb)	14.0	(6.4)
97770	Bracket Assembly, Cylinder, Marine (1000 lb)	16.0	(7.3)
98533	Manual-Pneumatic Valve Actuator (primary cylinders)	1.7	(0.8)
19589	Manual Valve Actuator (primary cylinders)	1.1	(0.5)
18772	Gauge Assembly, Pressure, FM-200 (all clean agent cylinders)	0.4	(0.2)
18775	Switch Assembly, Low-Pressure Supervisory, 360 psi (optional - all clean agent cylinders)	0.5	(0.2)
98660	Switch Assembly, Low-Pressure Supervisory, 360 psi, XP (optional - all clean agent cylinders)	0.5	(0.2)
18554	Coupling, Grooved, 3" (80 mm)	3.9	(1.8)
18550	Elbow, Grooved, 3" (80 mm)	4.7	(2.1)
17019	Pneumatic Valve Actuator (secondary cylinder)	1.2	(0.5)
10262	Valve, Check, 1/4" MNPT x 1/4" FNPT <i>NPT Style Actuation Check Valve</i>	0.3	(0.1)
18622	Tee, 1/4" JIC Male x 1/4" MNPT, Brass <i>Pilot Actuation Mid Line Tee</i>	0.2	(0.1)
10173	Vent Check	0.2	(0.1)
18625	Adapter, 1/4" MNPT x 1/4" JIC Male, Brass	0.2	(0.1)
18611	Tee, 1/4" FNPT x 1/4" MNPT, Brass <i>Pilot Actuation End Line Tee</i>	0.3	(0.1)
19192	Nipple, Hex, 1/4 Inch (8 mm) MNPT, Brass	0.2	(0.1)
99686	Coupling, Hex, 1/4 inch FNPT, 7/8 inch LG., Brass	0.2	(0.1)
99353	Elbow, 1/4 in MNPT x 1/4 in 45° Flared, Brass	0.2	(0.1)
18773	Switch, Discharge Pressure, Standard	1.4	(0.6)
18538	Valve, Check, Grooved, 3" (80 mm) <i>Manifold Check Valve</i>	25.0	(11.3)
18648	Hose, Flex, 3/16", 1/4" JIC Female, 16" long	0.6	(0.3)
18650	Hose, Flex, 3/16", 1/4" JIC Female, 34" long (recommended for 600 / 900 lb cylinder arrangements)	0.6	(0.3)
18651	Hose, Flex, 3/16", 1/4" JIC Female, 40" long (recommended for 1000 lb cylinder arrangements)	0.6	(0.3)
18777	Adapter, 1/4" JIC Male x 1/4" JIC Male, Brass <i>Flex Hose Adapter</i>	0.2	(0.1)
18489	Sign, Warning, Clean Agent, Exit	0.2	(0.1)
18770	Sign, Warning, Clean Agent, Entrance	0.2	(0.1)
Variable	Nozzle, 3/8", FM-200	0.5	(0.2)
Variable	Nozzle, 1/2", FM-200	0.6	(0.3)
Variable	Nozzle, 3/4", FM-200	0.8	(0.4)
Variable	Nozzle, 1", FM-200	1.2	(0.5)
Variable	Nozzle, 1-1/4", FM-200	1.6	(0.7)
Variable	Nozzle, 1-1/2", FM-200	1.7	(0.8)
Variable	Nozzle, 2", FM-200	3.6	(1.6)

¹ Specify the Cylinder Assembly P/N followed by a dash and the fill weight in pounds expressed in three digits
Example: 18528-815 - Cylinder Assembly, FM-200, 900 lb (815 lb fill)



Equipment List - Pneumatic Actuation Components

P/N	Description	Nominal Wt. lb (kg)	Ship (kg)
26101	Cylinder Assembly, Remote Nitrogen Actuation	15.0	(6.8)
97769	Bracket, Cylinder, 5.263 Inch (Remote Nitrogen Actuation Cylinder, 3.61 Liter)	10.0	(4.5)
97985	Marine Application Enclosure, w/ Remote Nitrogen Actuation Cylinder Assembly, One Cylinder	45.0	(20.4)
97984	Marine Application Enclosure, w/ Remote Nitrogen Actuation Cylinder Assembly, Two Cylinders	60.0	(27.2)
97987	Cylinder Connection, CGA 580 x 1/4 inch MNPT	0.4	(0.2)
99766	Valve, Pilot, 3-Way, 1/4 Inch, Aluminum, 3000PSI, No Exhaust <i>Pneumatic Stop Valve</i>	1.0	(0.5)
19598	Device, Header Safety, 1/2 Inch (15 mm) MNPT, HPCO2	0.5	(0.2)
19173	Valve, Ball, 1/4 Inch (8mm) FNPT, Brass	0.6	(0.3)

Equipment List - Cable-Pull Actuation Components

P/N	Description	Nominal Wt. lb (kg)	Ship (kg)
97722	Manual Cable Pull Station, Watertight, 3/8 in FNPT	2.5	(1.1)
97711	Cable Pull Stop Valve	1.9	(0.9)
97765	Corner Pulley, Cable Pull, for Marine, Brass, 3/8 in FNPT	0.5	(0.2)
97751	Cable Exit Guide, w/ Bracket, For Marine 3/8 in FNPT	1.0	(0.5)
12553	Cable, Remote Actuation, 1/16 in (1.59 mm), (Spool of 500 ft)	5.0	(2.7)
97758	Cable Operator, Dual-Pull, for Marine, 3/8 in FNPT	4.0	(1.8)

Equipment List - Nitrogen Driver Components

P/N	Description	Nominal Wt. lb (kg)	Ship (kg)
26093	Cylinder Assembly, Nitrogen Driver, 39.1 L	106.0	(48.1)
26094	Cylinder Assembly, Nitrogen Driver, 50.0 L	170.0	(77.1)
26095	Cylinder Assembly, Nitrogen Driver, 66.7 L	220.0	(99.8)
97768	Bracket, Cylinder, 8.495 Inch (Nitrogen Driver Cylinder, 39.1 Liter)	10.0	(4.5)
97767	Bracket, Cylinder, 9.165 Inch (Nitrogen Driver Cylinder, 50 Liter)	10.0	(4.5)
97766	Bracket, Cylinder, 10.56 Inch (Nitrogen Driver Cylinder, 66.7 Liter)	10.0	(4.5)
19589	Manual Valve Actuator (primary cylinders)	1.1	(0.5)
99707	Hose, Flex, Discharge, w/ Discharge Adapter, HPCO2	3.4	(1.5)
26096	Gauge Assembly, Nitrogen, 1800 PSI	0.4	(0.2)
26098	Gauge and Switch Assembly, Nitrogen, 1800 PSI	0.6	(0.3)



Equipment List - Time Delay and Siren Components

P/N	Description	Nominal Wt. lb (kg)	Ship (kg)
97691	Cabinet, Pilot, NEMA 4, w/Timer, w/o Solenoid Valve, w/o Supervision	42.0	(19.1)
19224	Siren, CO2, 3/8 Inch (10mm) FNPT	3.1	(1.4)
19225	Bracket, T, CO2, Siren	0.9	(0.4)
19316	Valve, Relief, 1/2 Inch (15 mm) MNPT, 125 PSI	1.2	(0.5)
99772	Regulator, 1/2 inch FNPT, Cv= 1.0, Max Inlet=3600PSI, Outlet 0-250PSI, SST	4.4	(2.0)
98656	Strainer, 1/2 Inch (15 mm) FNPT, Y, 40 Mesh, SST, Class 1500#	2.4	(1.1)
19370	Strainer, 1/2 Inch (15 mm) FNPT, Y, 40 Mesh, SST (FOR OPTIONAL SECONDARY SIREN LINE)	2.4	(1.1)
99767	Valve, Shuttle, 1/4 Inch, Brass, 3000PSI (FOR OPTIONAL SECONDARY SIREN LINE)	1.0	(0.5)
19599	Regulator, 1/4 Inch (8 mm) FNPT, Max Inlet=3600PSI, Outlet 0-250psi, Cv=0.5 (FOR OPTIONAL SECONDARY SIREN LINE)	4.5	(2.0)

Equipment List - Time Delay Cabinet Spares

P/N	Description	Nominal Wt. lb (kg)	Ship (kg)
19172	Timer, Pneumatic, 1/8 Inch (6 mm) FNPT	0.9	(0.4)
19173	Valve, Ball, 1/4 Inch (8mm) FNPT, Brass	0.6	(0.3)
19174	Valve, Pilot, 3-Way, 1/4 Inch (8mm) FNPT	1.9	(0.4)
99109	Filter, Inline, 1/4 Inch (8 mm) FNPT x MNPT, 20 Micron, Brass	0.1	(0.05)

The seller makes no warranties, express or implied, including, but not limited to, the implied warranties of merchantability and fitness for a particular purpose, except as expressly stated in the seller's sales contract or sales acknowledgment form. Every attempt is made to keep our product information up-to-date and accurate. All specific applications cannot be covered, nor can all requirements be anticipated. All specifications are subject to change without notice.



1102 Rupcich Drive
 Millennium Park
 Crown Point, IN 46307
 TEL: (219) 663-1600 FAX: (219) 663-4562
 e-mail: info@janusfiresystems.com
www.janusfiresystems.com