



Lv SERIES (360 psi)

CLEAN AGENT FIRE SUPPRESSION SYSTEM

FOR USE WITH 3M™ NOVEC™ 1230 FIRE PROTECTION FLUID

The Janus Fire Systems® Lv Series Clean Agent Fire Suppression System utilizes 3M™ Novec™ 1230 Fire Protection Fluid as the extinguishing medium. Novec 1230 fluid is a clear, colorless and low odor liquid perfectly suited to protect high value assets in areas that may be normally occupied, in locations where clean-up of other agents is problematic, when storage space for a fire suppression agent is restricted, or when an electrically non-conductive agent is required. Each system consists of the following components and their associated accessories:

1. **Agent Storage Components** - Storage components consist of the cylinder assembly(s), which contains the Novec 1230 fluid, and the cylinder bracket(s), which holds the cylinder assembly securely in place.
2. **Agent Fluid Distribution Components** - Distribution components consist of the discharge nozzles used to introduce the Novec 1230 fluid into a protected hazard along with the associated piping system used to connect the nozzles to the cylinder assembly.
3. **Trim Components** - Trim components complete the installation of the suppression system and consist of connection fittings, pressure gauge, low-pressure supervisory switch, electric valve actuator, and manual valve actuator.
4. **Multi-Cylinder Arrangement Components** - Multi-cylinder arrangement components consist of the pneumatic valve actuator(s), actuation check valve, vent check, actuation hose, and fittings required for a multiple cylinder (secondary) arrangement.
5. **Supplemental Components** - Supplemental components include the discharge pressure switch and manifold check valve. They supplement the core equipment or complete a specific multi-cylinder configuration.
6. **Control Panel** - This device monitors the condition of the electric actuator, detectors, warning devices, cylinder pressure, and any manual release and abort stations. All electric or electronic devices must connect to the control panel in order to function.
7. **Detection and Alarm Devices** - Detection devices coupled with manual release and abort stations maximize system efficiency while audible and visual alarm devices alert staff of alarm conditions.



Typical Clean Agent System Layout

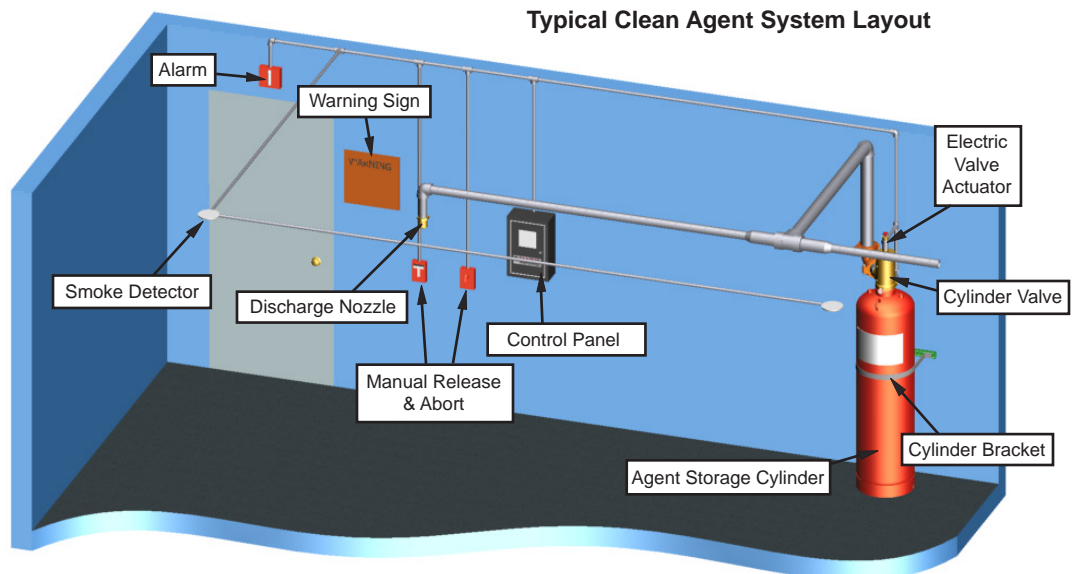



EQUIPMENT DESCRIPTION

The Novec 1230 fluid is stored as a liquid in cylinder assemblies designed specifically for the application and charged to a fill density of between 35 lb/ft³ (561 kg/m³) and 70 lb/ft³ (1121 kg/m³). To ensure optimal performance, each cylinder is superpressurized with dry nitrogen to 360 psi (24.8 bar) at 70°F (21°C). An identification label is affixed to the cylinder body indicating the fill quantity of Novec 1230 fluid, charging pressure, date of fill, and fill station. The Lv Series supports three cylinder capacities.

Fire suppression systems utilizing Novec 1230 fluid are designed to be discharged within 10 seconds into a room, area, or enclosure with the structural integrity to retain the agent. The Novec 1230 fluid uniformly mixes throughout the protect area achieving a minimum concentration level in accordance with NFPA 2001 and/or agency listings.

Nominal Cylinder Size	P/N	Fill Capacity				Empty Weight	
		Minimum		Maximum		lb	kg
		lb	kg	lb	kg		
600 lb	20508	304	137.9	609	276.2	346	157.0
900 lb	20509	455	206.4	910	412.7	471	213.6
1000 lb	20510	561	254.5	1000	453.6	766	346.5

The cylinder assembly is composed of a cylinder, dip tube, cylinder valve, rupture disc, and liquid level indicator.

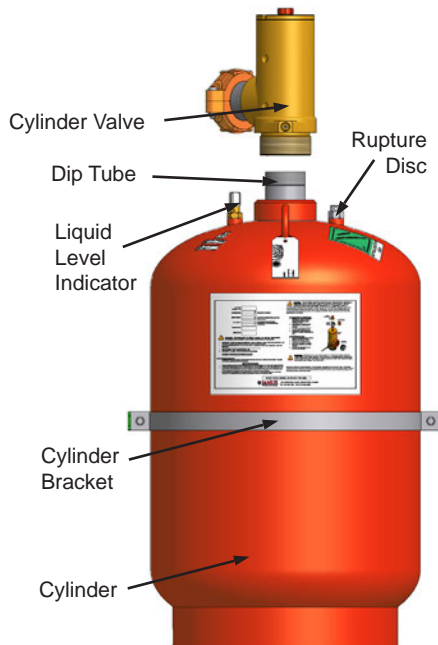

Cylinder Valve: The automatic release of Novec 1230 fluid is controlled by a forged brass, differential pressure operated cylinder valve connected to the neck of the cylinder. The valve assembly is shipped with an anti-recoil safety device installed in the discharge outlet and chained to the cylinder valve.

Dip Tube: A threaded, rigid dip tube extends from the cylinder neck down to its bottom.

Cylinder: The light walled, welded seam cylinder is manufactured according to the requirements of the U.S. Department of Transportation (USDOT) and Transport Canada (TC)¹ for compressed gas. Internal neck threads allow connection of the cylinder valve. The cylinder is designed for mounting in a vertical position only.

Rupture Disc: A frangible rupture disc is fitted to the cylinder body. It functions as an emergency relief device in the event of excessive pressure within the cylinder. Its rupture point is between 850 psi (58.6 bar) and 1000 psi (68.9 bar).

Liquid Level Indicator: A liquid level indicator located on the cylinder body is a nonmagnetic tube containing a measurement tape attached to a magnet. As the tape is removed, the magnet will engage at the liquid surface. This measurement is compared with a chart in the design manual to determine the current fill weight of the cylinder.

¹ 1000 lb Cylinder is not Transport Canada approved.

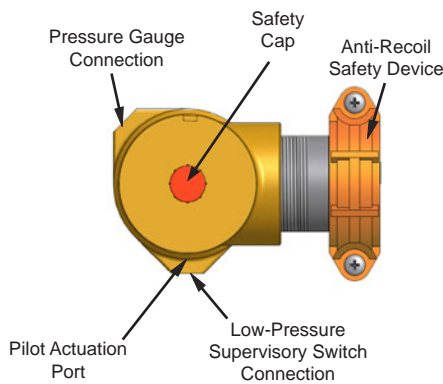
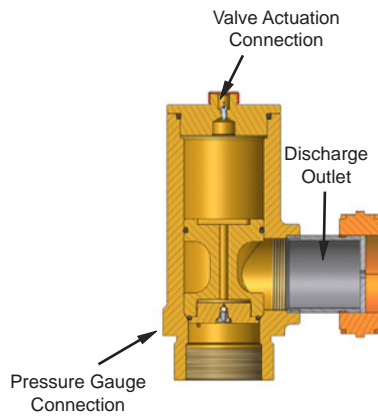

The cylinder valve has five connection points:

Valve Actuation Connection: A threaded connection located on top of the cylinder valve serves as the attachment point for the electric (primary) or pneumatic (secondary) valve actuator.

Pressure Gauge Connection: A female connection serves as the attachment point for the pressure gauge. It is fitted with an internal check valve to allow removal of the gauge while the cylinder is pressurized.

Low-Pressure Supervisory Switch Connection: A female connection serves as the attachment point for the low-pressure supervisory switch. An internal check valve allows for removal of the pressure switch while the cylinder is pressurized.

Discharge Outlet: A 3 in (80 mm) grooved connection serves as the attachment point for discharge piping.

Pilot Actuation Port: A 1/4 in (8 mm) FNPT connection (shipped with a removable plug) provides a means of applying actuation pressure to the secondary cylinder(s). This can also be used for attachment of the discharge pressure switch in single cylinder arrangements. The port is pressurized only during the 10 second discharge period.

CYLINDER MOUNTING

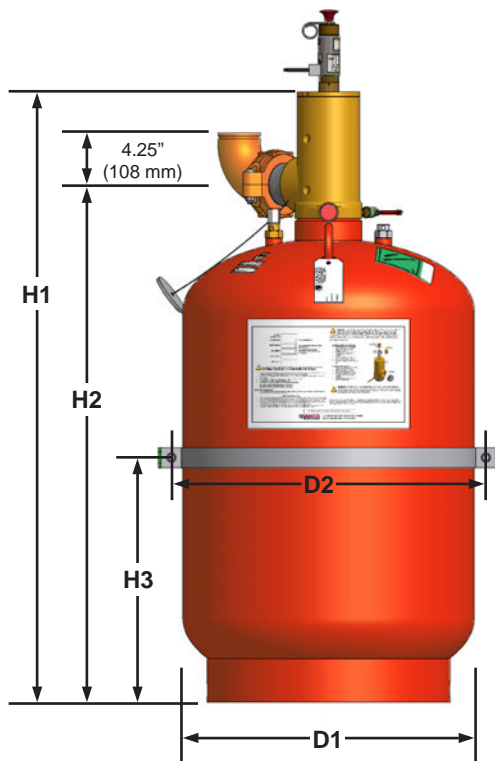

Wall Mount Cylinder Bracket Assembly (P/N See Chart)

Cylinder stability is ensured by the cylinder bracket assembly, consisting of one strap and rail with accompanying bolts, nuts, and washers. The rail is slotted for ease of mounting with fasteners provided by the installer.

	Cylinder Dimensions					
	600 lb		900 lb		1000 lb	
	in	mm	in	mm	in	mm
H1	52.56	1335	69.81	1773	61.39	1559
H2	44.92	1141	62.17	1579	53.73	1365
H3	21.5	546	38.0	965	30.0	762
D1	24.0	610	24.0	610	30.0	762
D2	25.9	658	25.9	658	31.9	810
P/N	18536		18536		18537	



TRIM COMPONENTS

Trim components are required to operate the clean agent cylinder(s).

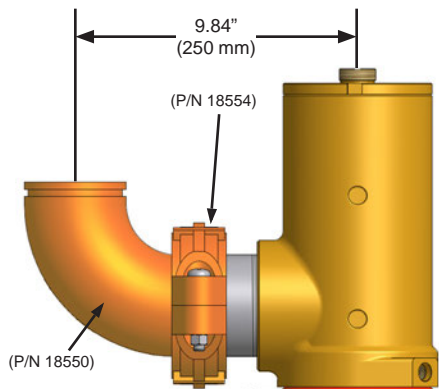
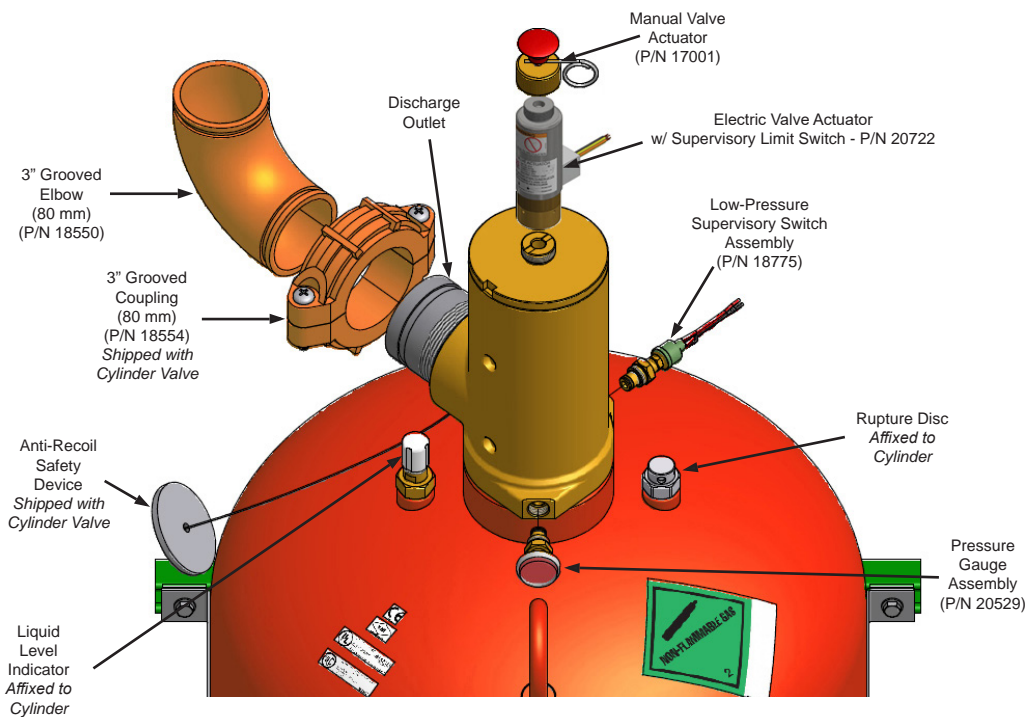

Discharge Connection Fittings (P/N See Diagram)

A 3 in (80 mm) grooved elbow connects to the grooved cylinder outlet adapter utilizing the coupling factory installed to retain the anti-recoil safety device. Pipe and fittings beyond the 3 in (80 mm) elbow are to be supplied by the installer.

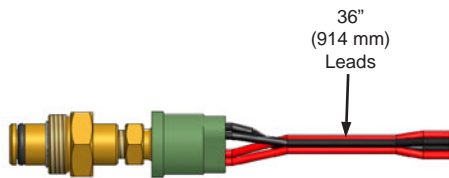

Low-Pressure Supervisory Switch Assembly (P/N 18775)

The low-pressure supervisory switch continuously monitors the pressure of the cylinder. The contact configuration is single pole, single throw (SPST) with contacts rated 1.5 Amps at 24 VDC. Should the cylinder pressure drop to approximately 280 psi (19.3 bar), the switch contacts will close transmitting an abnormal signal to the system control panel.

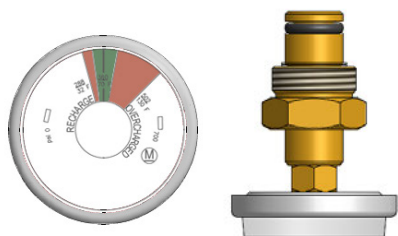

Pressure Gauge Assembly (P/N 20529)

NFPA 2001 mandates a pressure gauge for each cylinder as a method of visually monitoring the internal pressure condition of the cylinder assembly.



1/2" (15 mm) NPS Female Conduit Hub with 40" (1016 mm) leads
Knurled Swivel Nut

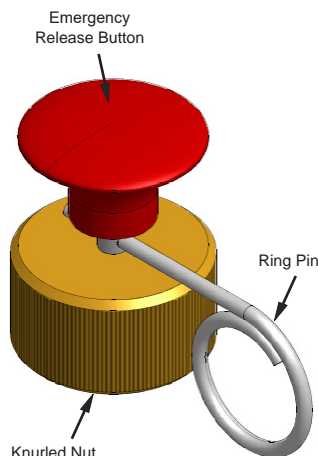

Knurled Nut

Electric Valve Actuator w/ Supervisory Limit Switch¹ (P/N 20722)

The electric valve actuator attaches to the primary cylinder at the valve actuation connection and is utilized to automatically open the cylinder valve upon receipt of a signal from the control panel or other source. It operates between 17 and 30 VDC and consumes 500 mA (.5 Amps) at 24 VDC nominal with a maximum supervisory current of 30 mA (0.03 Amps).

The electric valve actuator body is steel construction with a brass knurled swivel nut and a stainless steel actuation pin that depresses the valve core when energized. The limit switch contacts are normally closed when the actuator is not installed onto the cylinder valve and open when the actuator is fully installed onto the valve actuation connection at the top of the cylinder valve.

Manual Valve Actuator (P/N 17001)

An optional manual valve actuator attaches to the top of the electric valve actuator and provides a means to manually open the cylinder valve. The manual valve actuator consists of a brass body, stainless steel actuation pin, and steel safety ring pin.

To discharge the primary cylinder manually, the ring pin is removed and the emergency release button is depressed forcing the pin in the electric valve actuator to depress the valve core of the cylinder valve. All other connected cylinders will be opened pneumatically.

MULTI-CYLINDER ARRANGEMENT COMPONENTS

Up to 16 cylinders (1 primary and 15 secondary) may be installed in a single arrangement, with a maximum length of 100 ft (30.48 m) of pilot actuation hose or tubing extending from the primary cylinder in either direction. A typical arrangement is shown below.

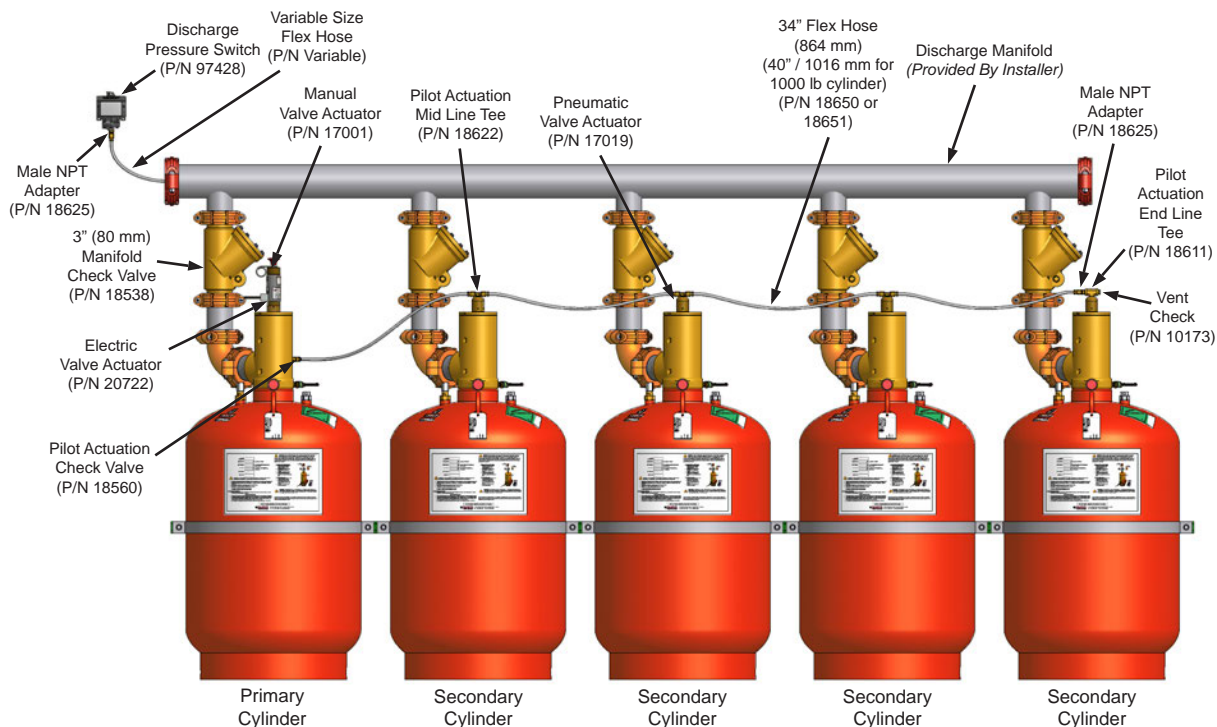

Typical Primary and Secondary Cylinder Arrangement

¹ Effective January 1, 2016, NFPA 2001 requires that the removal of an electric actuator from the agent storage container discharge valve that it controls shall result in an audible and visual indication of system impairment at the system releasing control panel.

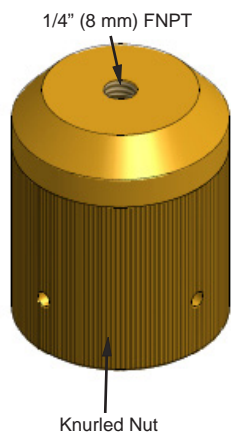

Pneumatic Valve Actuator (P/N 17019)

On multiple cylinder systems the electric valve actuator will open the primary cylinder and then, in a rapidly occurring sequence, the pneumatic valve actuator(s) will open all other cylinders using pressure from the primary cylinder.

A pneumatic valve actuator attaches to the valve actuation connection of each secondary cylinder. It receives pressure from the pilot actuation port of the primary cylinder through the pilot actuation check valve. It is brass with a brass piston and pin.

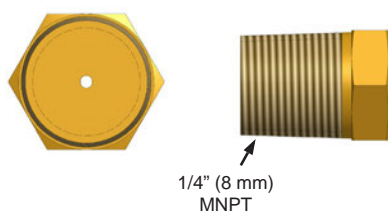

Vent Check (P/N 10173)

The vent check is a safety device with 1/4 in (8 mm) MNPT threads that is to be installed in the pilot actuation line downstream of the pilot actuation check valve. It is used to bleed off pressure that may accumulate in the pilot actuation hose or piping minimizing the chance of inadvertent pressurization of the pneumatic actuators or discharge pressure switch.

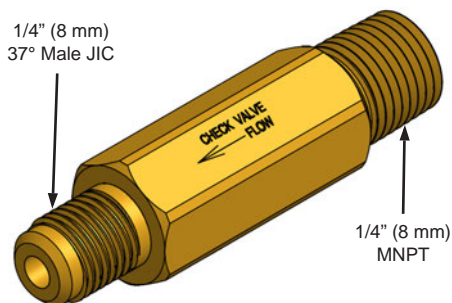

Pilot Actuation Check Valve (P/N 18560)

A 1/4 in (8 mm) MNPT by 37° male JIC check valve is installed in the pilot actuation port of the primary cylinder valve with direction of flow OUT of the valve. When the valve opens, pressure will be directed through the pilot actuation check valve to the pneumatic valve actuators on the secondary cylinders. The purpose of the pilot actuation check valve is to ensure the pneumatic actuator(s) remain pressurized for the entire discharge period.

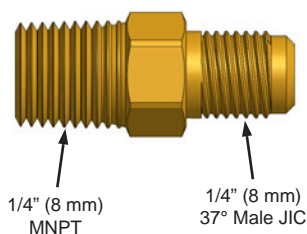

Male NPT Adapter (P/N 18625)

A 1/4 in (8 mm) 37° male JIC by MNPT adapter fits into the pilot actuation end line tee of the final secondary cylinder to facilitate the attachment of the pilot actuation line. It also may be utilized to allow the attachment of flex hose to the discharge pressure switch.

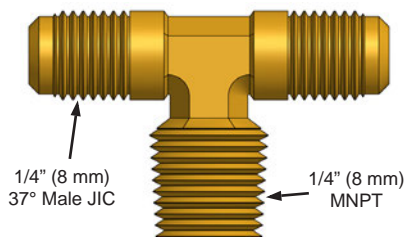

Pilot Actuation Mid Line Tee (P/N 18622)

A 1/4 in (8 mm) 37° male JIC by MNPT brass branch tee is utilized to attach the pilot actuation line to the pneumatic valve actuator.

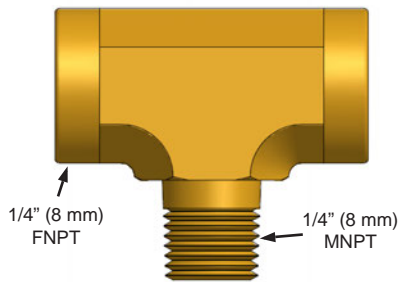

Pilot Actuation End Line Tee (P/N 18611)

A 1/4 in (8 mm) FNPT by MNPT brass branch tee mounts to the final pneumatic valve actuator to facilitate attachment of the vent check to the pilot actuation line.

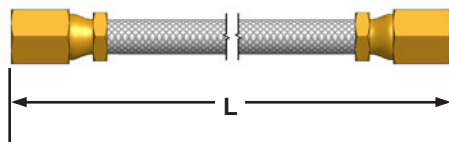

Flex Hose (P/N See Chart)

Flex hoses are 3/16 in (7 mm) Teflon® lined stainless steel wire braided hoses of varying lengths with 1/4 in (8 mm) 37° female JIC flare fittings. They are utilized to interconnect cylinders when a multi-cylinder arrangement is required. A 1/4 in (8 mm) 37° male JIC flare x male JIC flare adapter (P/N 18777) is available to connect lengths of flex hose together.

P/N	Hose Length (L)
18648	16 in (406 mm)
18649	24 in (610 mm)
18650	34 in (864 mm)
18651	40 in (1016 mm)

SUPPLEMENTAL COMPONENTS

Supplemental components complete various system arrangements.

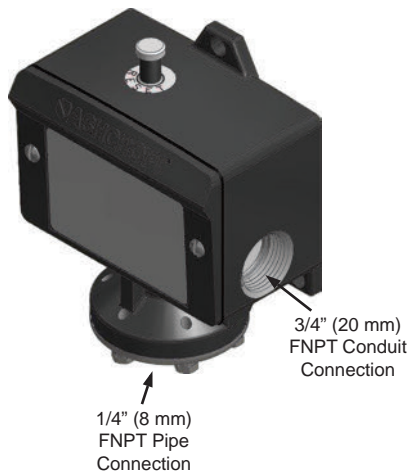

Discharge Pressure Switch (P/N 97428)

The discharge pressure switch is used in the system to provide positive indication of agent discharge and to initiate the shut down of equipment that may deplete agent concentration. The pressure switch is a single pole, double throw (SPDT) switch with contacts rated 15 Amps at 125/250/480 VAC and 0.5 Amps at 125 VDC. It has a NEMA 4X enclosure.

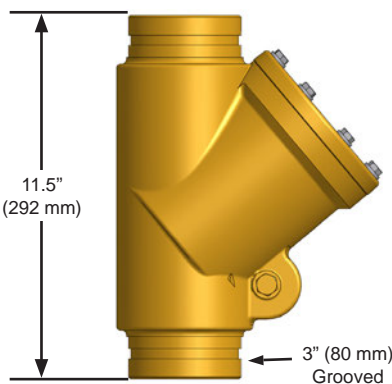

Manifold Check Valve (P/N 18538)

In a multiple cylinder arrangement where the secondary and primary cylinders share a common manifold or in a main / reserve arrangement, a 3 in (80 mm) grooved manifold check valve must be placed between the discharge outlet of each cylinder and the discharge manifold to prevent back flow from the manifold should the system be inadvertently discharged when one or more cylinders are disconnected for maintenance.



DISCHARGE NOZZLES

Discharge nozzles (4, 6, or 8 ports) are used to uniformly distribute the Novec 1230 fluid. They are performance tested to ensure that the agent is discharged within 10 seconds and properly dispersed throughout the protected area. Maximum nozzle height for a protected space is 18 ft 4 in (5588 mm) per tier of nozzles. Additional tiers are required for heights greater than 18 ft 4 in.

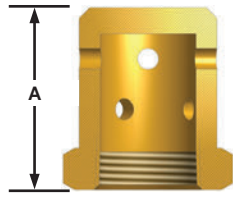

Discharge Nozzle
Cut View



Discharge Nozzle
Top View

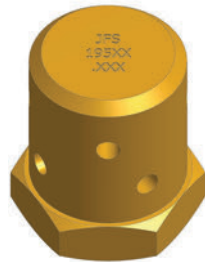

360° Radial Nozzle (8 Port)

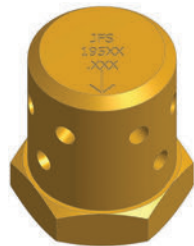

180° Sidewall Nozzle (6 Port)

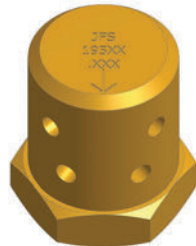

90° Corner Nozzle (4 Port)

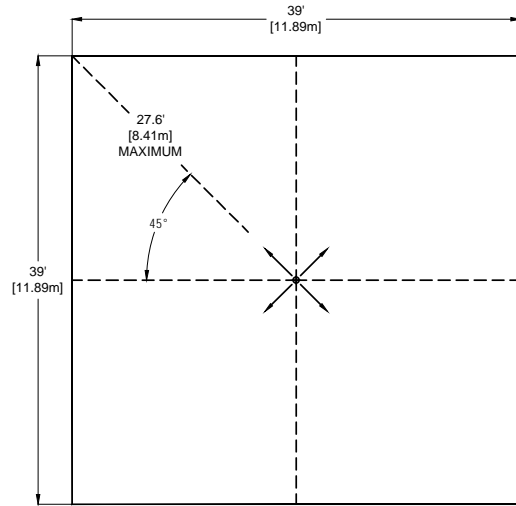

360° Radial Nozzle (8 Port)
Arrangement

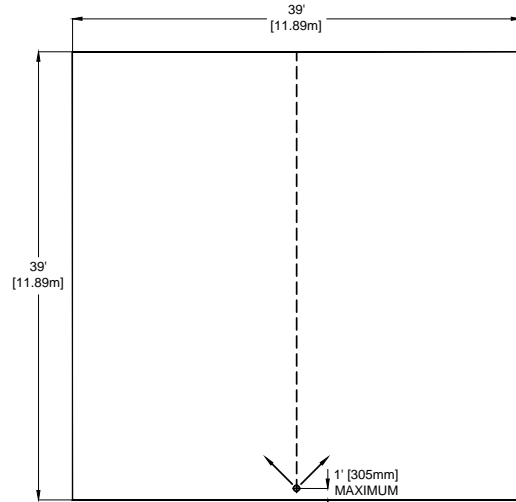

180° Sidewall Nozzle (6 Port)
Arrangement

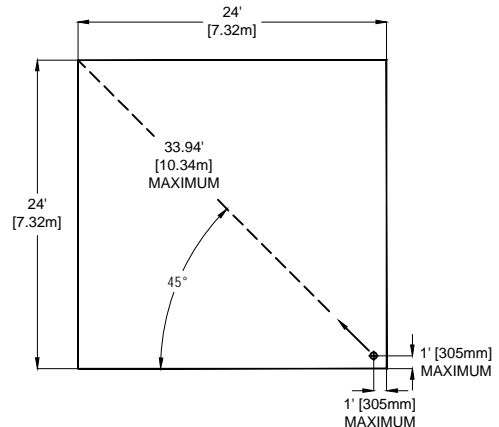

90° Corner Nozzle (4 Port)
Arrangement



Nozzle Orientation Part Number						Nominal Pipe Size	Nozzle Height (A)	
Brass			Stainless Steel				in	mm
360°	180°	90°	360°	180°	90°			
19529	19522	19515	20445	20438	20431	3/8 in (10mm)	1.436	36.5
19530	19523	19516	20446	20439	20432	1/2 in (15 mm)	1.722	43.7
19531	19524	19517	20447	20440	20433	3/4 in (20 mm)	1.926	48.9
19532	19525	19518	20448	20441	20434	1 in (25 mm)	2.176	55.3
19533	19526	19519	20449	20442	20435	1 1/4 in (32 mm)	2.500	63.5
19534	19527	19520	20450	20443	20436	1 1/2 in (40 mm)	2.689	68.3
19535	19528	19521	20451	20444	20437	2 in (50 mm)	3.100	78.7

Ordering Instructions: Specify the Nozzle P/N followed by a dash and the three digits representative of the drill code as provided by the Janus Design Suite® software.
 Example: 19529-XXX = Nozzle: 360°, 3/8" (10 mm), Brass (with drill code as specified)

CHEMICAL PROPERTIES OF NOVEC 1230 FLUID

Novec 1230 fluid is formed from the elements carbon, fluorine and oxygen [CF₃CF₂C(O)CF(CF₃)₂ - dodecafluoro-2-methylpentan-3-one]. The primary extinguishing mechanism of Novec 1230 fluid is heat absorption, with a secondary chemical contribution from the thermal decomposition of Novec 1230 fluid in the flame. Novec 1230 fluid leaves no residue and is safe for use in occupied spaces.

Ozone Depletion Potential (ODP) – Novec 1230 fluid is a highly fluorinated ketone containing no chlorine or bromine. As a result, the ODP for Novec 1230 fluid is zero, meaning it has no effect on stratospheric ozone.

Global Warning Potential (GWP) – Novec 1230 fluid has an atmospheric lifetime of only 0.014 years. The global warning potential for all practical purposes is negligible.

SAFETY CONSIDERATIONS

Although the EPA Significant New Alternative Program (SNAP) lists Novec 1230 fluid as acceptable for occupied spaces, NFPA Standard 2001 and SNAP list the following guidelines for human exposure:

Novec 1230 fluid has a NOAEL¹ of 10.0% v/v with no restrictions. The maximum exposure time shall not exceed five (5) minutes. Avoid any exposure greater than 10% v/v (LOAEL²).

The discharge of Novec 1230 fluid into a hazard may reduce visibility for a brief period.

When Novec 1230 fluid is exposed to extremely high temperatures, the by-product Hydrogen Fluoride (HF) will be formed. Novec 1230 fire protection fluid systems are designed to discharge in 10 seconds or less in order to minimize the amount of HF formed.

The Material Safety Data Sheet (MSDS) on Novec 1230 fluid should be read and understood prior to working with the agent.

A cylinder containing Novec 1230 fluid should be handled carefully. **The anti-recoil safety device must be in place at all times when the cylinder is not connected to the discharge piping and restrained.**

¹ NOAEL (No Observed Adverse Effect Level) - The highest concentration at which no adverse toxicological or physiological effect has been observed.

² LOAEL (Lowest Observable Adverse Effect Level) - The lowest concentration at which an adverse physiological or toxicological effect has been observed.



Order Review List		
P/N	Description	Nominal Ship Wt. lb (kg)
20508 ¹	Cylinder Assembly, Novec 1230 Fluid, 600 lb (360 psi / 24.8 bar) (304 to 607 lb capacity / 137.9 to 275.3 kg)	346 (157.0)
20509 ¹	Cylinder Assembly, Novec 1230 Fluid, 900 lb (360 psi / 24.8 bar) (455 to 910 lb capacity / 206.4 to 412.8 kg)	471 (213.6)
20510 ¹	Cylinder Assembly, Novec 1230 Fluid, 1000 lb (360 psi / 24.8 bar) (619 to 1000 lb capacity / 280.8 to 453.6 kg)	766 (346.5)
NOVEC1230	Bulk Novec 1230 Fluid	Variable
18536	Bracket Assembly, Cylinder (600 lb / 900 lb)	10.0 (4.5)
18537	Bracket Assembly, Cylinder (1000 lb)	12.0 (5.4)
20722	Electric Valve Actuator w/ Supervisory Limit Switch (primary cylinder)	2.0 (0.9)
18481	Electric Valve Actuator w/o Supervisory Limit Switch (primary cylinder)	2.0 (0.9)
17001	Manual Valve Actuator (primary cylinder)	0.6 (0.3)
20529	Gauge Assembly, Pressure, Novec 1230 Fluid (all cylinders)	0.4 (0.2)
18775	Switch Assembly, Low-Pressure Supervisory (recommended all cylinders)	0.5 (0.2)
18554	Coupling, Grooved, 3" (80 mm)	3.9 (1.8)
18550	Elbow, Grooved, 3" (80 mm)	4.7 (2.1)
17019	Pneumatic Valve Actuator (secondary cylinder)	1.2 (0.5)
18560	Valve, Check, 1/4" JIC Male x 1/4" MNPT <i>Pilot Actuation Check Valve</i>	0.3 (0.1)
18622	Tee, 1/4" JIC Male x 1/4" MNPT, Brass <i>Pilot Actuation Mid Line Tee</i>	0.2 (0.1)
10173	Vent Check (connects to Pilot Actuation End Line Tee)	0.2 (0.1)
18625	Adapter, 1/4" MNPT x 1/4" JIC Male, Brass <i>Male NPT Adapter</i> (connects to Pilot Actuation End Line Tee)	0.2 (0.1)
18611	Tee, 1/4" FNPT x 1/4" MNPT, Brass <i>Pilot Actuation End Line Tee</i>	0.3 (0.1)
18773	Switch, Discharge Pressure	1.4 (0.6)
18538	Valve, Check, Grooved, 3" (80 mm) <i>Manifold Check Valve</i>	25.0 (11.3)
18650	Hose, Flex, 3/16", 1/4" JIC Female, 34" long (recommended for 600 / 900 lb cylinder arrangements)	0.6 (0.3)
18651	Hose, Flex, 3/16", 1/4" JIC Female, 40" long (recommended for 1000 lb cylinder arrangements)	0.6 (0.3)
18777	Adapter, 1/4" JIC Male x 1/4" JIC Male, Brass <i>Flex Hose Adapter</i>	0.2 (0.1)
Variable	Nozzle, 3/8", Novec 1230 Fluid	0.5 (0.2)
Variable	Nozzle, 1/2", Novec 1230 Fluid	0.6 (0.3)
Variable	Nozzle, 3/4", Novec 1230 Fluid	0.8 (0.4)
Variable	Nozzle, 1", Novec 1230 Fluid	1.2 (0.5)
Variable	Nozzle, 1-1/4", Novec 1230 Fluid	1.6 (0.7)
Variable	Nozzle, 1-1/2", Novec 1230 Fluid	1.7 (0.8)
Variable	Nozzle, 2", Novec 1230 Fluid	3.6 (1.6)

¹ Specify the Cylinder Assembly P/N followed by a dash and the fill weight in pounds expressed in three digits
Example: 20509-815 - Cylinder Assembly, Novec 1230 Fluid, 900 lb (815 lb fill)

The seller makes no warranties, express or implied, including, but not limited to, the implied warranties of merchantability and fitness for a particular purpose, except as expressly stated in the seller's sales contract or sales acknowledgment form. Every attempt is made to keep our product information up-to-date and accurate. All specific applications cannot be covered, nor can all requirements be anticipated. All specifications are subject to change without notice.



1102 Rupcich Drive
Millennium Park
Crown Point, IN 46307
TEL: (219) 663-1600 FAX: (219) 663-4562
e-mail: info@janusfiresystems.com
www.janusfiresystems.com